

# Junior Cup 2003



## RESULTS



**22.- 24.05.2003**  
**Templin / Germany**

**DEUTSCHER SCHÜTZENBUND E.V.**  
**GERMAN SHOOTING FEDERATION**

**Deutscher Schützenbund e.V.**  
**European Junior Cup 2003 Templin /GER**  
**von 20.5. - 24.5. 2003**

**Individual Ranking Results**

Recurve Cadet Men

**Recurve Cadet Men**

|    | Target | BackNr | Name                 | NOC | 70 m/Rk  | 70 m/Rk  | Hits | 10's | X's | Total |
|----|--------|--------|----------------------|-----|----------|----------|------|------|-----|-------|
| 1  | 24A    | 147    | FLOTO, Florian       | GER | 332 / 1  | 320 / 2  | 72   | 26   | 9   | 652   |
| 2  | 28C    | 141    | GIROULLE, Romain     | FRA | 321 / 2  | 327 / 1  | 72   | 28   | 4   | 648   |
| 3  | 29C    | 110    | ANDREAS, Milan       | CZE | 306 / 7  | 317 / 3  | 72   | 16   | 4   | 623   |
| 4  | 30B    | 236    | DEMIRKAN, Recep      | TUR | 304 / 9  | 316 / 4  | 72   | 12   | 4   | 620   |
| 5  | 24C    | 249    | MIGURA, Artem        | UKR | 316 / 3  | 300 / 9  | 72   | 16   | 3   | 616   |
| 6  | 27A    | 154    | NEUSIUS, Bastian     | GER | 310 / 4  | 305 / 6  | 72   | 14   | 1   | 615   |
| 7  | 24D    | 174    | DECKER, Gilles       | LUX | 299 / 11 | 312 / 5  | 72   | 17   | 5   | 611   |
| 8  | 25A    | 159    | VENNEMANN, Dennis    | GER | 309 / 6  | 302 / 7  | 72   | 15   | 3   | 611   |
| 9  | 24B    | 181    | GALCZYNSKI, Hubert   | POL | 310 / 5  | 295 / 12 | 72   | 14   | 1   | 605   |
| 10 | 26B    | 180    | DOBZYNSKI, Jacek     | POL | 305 / 8  | 300 / 10 | 72   | 13   | 1   | 605   |
| 11 | 25B    | 191    | SULEK, Przemyslaw    | POL | 297 / 12 | 296 / 11 | 72   | 16   | 4   | 593   |
| 12 | 25C    | 244    | HAVELKO, Yuriy       | UKR | 295 / 14 | 295 / 13 | 72   | 9    | 2   | 590   |
| 13 | 26C    | 252    | SENIK, Martyn        | UKR | 297 / 13 | 288 / 17 | 72   | 7    | 2   | 585   |
| 14 | 28D    | 222    | HENNINGSSON, Jonny   | SWE | 287 / 16 | 294 / 14 | 72   | 7    | 2   | 581   |
| 15 | 30C    | 230    | TAPPER, Martin       | SWE | 280 / 19 | 300 / 8  | 72   | 11   | 5   | 580   |
| 16 | 26D    | 175    | HENCKELS, Jerry      | LUX | 286 / 17 | 292 / 16 | 72   | 9    | 1   | 578   |
| 17 | 26A    | 162    | WOLLMANN, Patric     | GER | 301 / 10 | 274 / 21 | 72   | 7    | 1   | 575   |
| 18 | 28B    | 201    | LUKANCIC, Jadran     | SLO | 291 / 15 | 283 / 18 | 70   | 10   | 5   | 574   |
| 19 | 28A    | 212    | GALIK, Martin        | SVK | 277 / 20 | 292 / 15 | 72   | 7    | 2   | 569   |
| 20 | 27D    | 223    | HJALMASSON, Johannes | SWE | 280 / 18 | 282 / 20 | 72   | 8    | 3   | 562   |
| 21 | 27B    | 189    | RAUK, Tomasz         | POL | 260 / 23 | 282 / 19 | 72   | 6    | 0   | 542   |
| 22 | 27C    | 243    | DUDNIK, Denys        | UKR | 274 / 21 | 259 / 23 | 71   | 5    | 0   | 533   |
| 23 | 29B    | 202    | MALJEVAC, Josip      | SLO | 251 / 25 | 260 / 22 | 68   | 6    | 0   | 511   |
| 24 | 29A    | 214    | ZUBAL, Juraj         | SVK | 259 / 24 | 247 / 24 | 71   | 3    | 1   | 506   |
| 25 | 25D    | 177    | GLESENER, Daniel     | LUX | 271 / 22 | 223 / 25 | 69   | 4    | 1   | 494   |
| 26 | 30A    | 134    | LINDMAA, Siim        | EST | 217 / 26 | 208 / 26 | 70   | 1    | 1   | 425   |

**Recurve Cadet Women**

|    | Target | BackNr | Name                  | NOC | 70 m/Rk  | 70 m/Rk  | Hits | 10's | X's | Total |
|----|--------|--------|-----------------------|-----|----------|----------|------|------|-----|-------|
| 1  | 19B    | 156    | POSSNER, Susanne      | GER | 324 / 1  | 304 / 1  | 72   | 15   | 4   | 628   |
| 2  | 23B    | 238    | LÖKLÜOGLU, Begül      | TUR | 310 / 2  | 290 / 4  | 72   | 15   | 3   | 600   |
| 3  | 19C    | 241    | DOBRYEVA, Halyna      | UKR | 298 / 3  | 299 / 2  | 72   | 13   | 1   | 597   |
| 4  | 20B    | 151    | LEVEN, Nadine         | GER | 289 / 7  | 296 / 3  | 72   | 14   | 7   | 585   |
| 5  | 21A    | 183    | LIPIARSKA, Karina     | POL | 296 / 4  | 285 / 6  | 71   | 12   | 3   | 581   |
| 6  | 20D    | 200    | KRIZE, Barbara        | SLO | 285 / 9  | 288 / 5  | 72   | 6    | 3   | 573   |
| 7  | 21B    | 153    | GANSEN, Melanie       | GER | 292 / 6  | 280 / 9  | 72   | 7    | 3   | 572   |
| 8  | 19A    | 187    | NIEMIEC, Ursula       | POL | 284 / 10 | 283 / 7  | 72   | 11   | 1   | 567   |
| 9  | 22B    | 158    | UNRUH, Lisa           | GER | 295 / 5  | 271 / 12 | 72   | 12   | 4   | 566   |
| 10 | 23C    | 144    | VANDJOUR, Marjorie    | FRA | 282 / 11 | 278 / 10 | 72   | 8    | 1   | 560   |
| 11 | 21C    | 245    | KALLINICHENKO, Milana | UKR | 276 / 12 | 281 / 8  | 72   | 7    | 0   | 557   |
| 12 | 20C    | 250    | NOVIKOVA, Ityna       | UKR | 287 / 8  | 269 / 14 | 71   | 8    | 2   | 556   |
| 13 | 22A    | 185    | MIERZWA, Justyna      | POL | 265 / 13 | 271 / 13 | 72   | 7    | 3   | 536   |
| 14 | 23A    | 108    | VONDEVOORDE, Aurore   | BEL | 261 / 14 | 272 / 11 | 72   | 6    | 1   | 533   |
| 15 | 19D    | 209    | ZLENDER, Maja         | SLO | 259 / 15 | 269 / 15 | 70   | 7    | 1   | 528   |
| 16 | 22D    | 227    | LARSSON, Petra        | SWE | 255 / 17 | 265 / 16 | 72   | 2    | 0   | 520   |
| 17 | 20A    | 190    | STRZELCZYK, Ena       | POL | 258 / 16 | 239 / 18 | 72   | 0    | 0   | 497   |
| 18 | 22C    | 135    | PREIMANN, Annelly     | EST | 191 / 18 | 251 / 17 | 71   | 4    | 0   | 442   |
| 19 | 21D    | 221    | FORS, Sanna           | SWE | 118 / 19 | 174 / 19 | 49   | 4    | 0   | 292   |

## Recurve Junior Men

|    | Target | BackNr | Name                    | NOC | 70 m/Rk  | 70 m/Rk  | Hits | 10's | X's | Total |
|----|--------|--------|-------------------------|-----|----------|----------|------|------|-----|-------|
| 1  | 17A    | 168    | SCAMMACCA, Ignazio      | ITA | 331 / 2  | 313 / 10 | 72   | 21   | 3   | 644   |
| 2  | 13C    | 142    | HELLYNCK, Julien        | FRA | 319 / 3  | 320 / 1  | 72   | 24   | 11  | 639   |
| 3  | 23A    | 203    | MAZGON, Rok             | SLO | 336 / 1  | 302 / 22 | 72   | 20   | 8   | 638   |
| 4  | 14D    | 152    | LUCKE, Tim              | GER | 317 / 5  | 320 / 2  | 72   | 21   | 5   | 637   |
| 5  | 19A    | 163    | ANDERLE, Alessandro     | ITA | 318 / 4  | 318 / 3  | 72   | 20   | 8   | 636   |
| 6  | 18C    | 232    | AGDERE, Bahadir         | TUR | 314 / 7  | 313 / 12 | 72   | 14   | 2   | 627   |
| 7  | 17C    | 237    | KOLAY, Tayfun           | TUR | 309 / 12 | 317 / 5  | 72   | 12   | 4   | 626   |
| 8  | 15D    | 150    | IGGENA, Jan             | GER | 311 / 8  | 313 / 8  | 72   | 20   | 4   | 624   |
| 9  | 18B    | 192    | SZOKAL-EGIRD, Krzysztof | POL | 309 / 13 | 313 / 9  | 72   | 13   | 4   | 622   |
| 10 | 15C    | 145    | VARECHON, Dimitri       | FRA | 307 / 15 | 314 / 7  | 72   | 17   | 8   | 621   |
| 11 | 13A    | 246    | KRYVOCHENKO, Oleksiy    | UKR | 311 / 9  | 310 / 13 | 72   | 14   | 3   | 621   |
| 12 | 15A    | 242    | DUBAS, Igor             | UKR | 301 / 22 | 318 / 4  | 72   | 15   | 2   | 619   |
| 13 | 21C    | 229    | OLOFSSON, Martin        | SWE | 301 / 20 | 313 / 11 | 72   | 14   | 4   | 614   |
| 14 | 23B    | 111    | HLAVA, Alegs            | CZE | 309 / 11 | 303 / 19 | 72   | 10   | 3   | 612   |
| 15 | 16A    | 253    | ZABOLYAN, Oleksandr     | UKR | 316 / 6  | 295 / 30 | 71   | 14   | 6   | 611   |
| 16 | 14A    | 251    | PERKOV, Oleksandr       | UKR | 303 / 17 | 306 / 16 | 72   | 17   | 4   | 609   |
| 17 | 18A    | 170    | TONELLI, Amedeo         | ITA | 309 / 10 | 300 / 26 | 72   | 15   | 5   | 609   |
| 18 | 17B    | 184    | MIENKOWSKI, Jerzy       | POL | 308 / 14 | 301 / 24 | 72   | 14   | 5   | 609   |
| 19 | 18D    | 128    | POULSEN, Jacob Rujd     | DEN | 305 / 16 | 300 / 27 | 72   | 17   | 6   | 605   |
| 20 | 19C    | 239    | ÖZCELIK, Memmet Ali     | TUR | 301 / 21 | 304 / 17 | 72   | 14   | 5   | 605   |
| 21 | 23C    | 102    | DE WACHTER, Kristof     | BEL | 296 / 25 | 307 / 14 | 72   | 13   | 4   | 603   |
| 22 | 20B    | 179    | CIS, Tomasz             | POL | 294 / 29 | 307 / 15 | 72   | 12   | 1   | 601   |
| 23 | 17D    | 121    | JAKOBSEN, Franz L.      | DEN | 302 / 19 | 298 / 29 | 72   | 9    | 1   | 600   |
| 24 | 20D    | 178    | VASAUNE, David          | LUX | 284 / 35 | 315 / 6  | 72   | 16   | 4   | 599   |
| 25 | 21A    | 206    | POVZ, Matej             | SLO | 298 / 24 | 300 / 25 | 72   | 15   | 5   | 598   |
| 26 | 13D    | 148    | GINZEL, Jan-Christoper  | GER | 295 / 26 | 302 / 21 | 72   | 13   | 6   | 597   |
| 27 | 21B    | 112    | MIKESKA, Jakub          | CZE | 303 / 18 | 292 / 33 | 72   | 10   | 0   | 595   |
| 28 | 19D    | 127    | PEDERSEN, Kasper S.     | DEN | 290 / 31 | 302 / 20 | 72   | 16   | 6   | 592   |
| 29 | 20C    | 215    | AKESSON, Philip         | SWE | 300 / 23 | 292 / 32 | 71   | 10   | 2   | 592   |
| 30 | 20A    | 167    | CROCE, Valerio          | ITA | 288 / 33 | 301 / 23 | 72   | 12   | 4   | 589   |
| 31 | 19B    | 182    | KOWALSKI, Bartlomiej    | POL | 289 / 32 | 298 / 28 | 72   | 9    | 4   | 587   |
| 32 | 14C    | 143    | PAYA, Brice             | FRA | 294 / 28 | 291 / 34 | 72   | 8    | 6   | 585   |
| 33 | 16B    | 136    | SELTNER, Tarmo          | EST | 295 / 27 | 289 / 36 | 72   | 8    | 2   | 584   |
| 34 | 16C    | 146    | VOIRIN, Guillaume       | FRA | 291 / 30 | 292 / 31 | 72   | 11   | 6   | 583   |
| 35 | 16D    | 160    | WIESSE, Lutz            | GER | 278 / 37 | 304 / 18 | 72   | 14   | 4   | 582   |
| 36 | 22A    | 208    | SORLI, Damijan          | SLO | 288 / 34 | 286 / 37 | 72   | 7    | 2   | 574   |
| 37 | 13B    | 133    | KUKK, Eimar             | EST | 281 / 36 | 280 / 39 | 72   | 8    | 2   | 561   |
| 38 | 22B    | 114    | TROJAN, Radek           | CZE | 267 / 38 | 289 / 35 | 71   | 11   | 3   | 556   |
| 39 | 22C    | 231    | THORIN, Cristopher      | SWE | 238 / 41 | 285 / 38 | 72   | 5    | 3   | 523   |
| 40 | 15B    | 131    | EINROOS, Erki           | EST | 259 / 39 | 258 / 40 | 72   | 4    | 2   | 517   |
| 41 | 14B    | 132    | KOPPEL, Victor          | EST | 258 / 40 | 229 / 41 | 72   | 1    | 0   | 487   |

## Recurve Junior Women

|    | Target | BackNr | Name                  | NOC | 70 m/Rk  | 70 m/Rk  | Hits | 10's | X's | Total |
|----|--------|--------|-----------------------|-----|----------|----------|------|------|-----|-------|
| 1  | 24C    | 161    | WINTER, Karina        | GER | 315 / 1  | 308 / 4  | 72   | 16   | 7   | 623   |
| 2  | 25C    | 149    | HILLER, Halina        | GER | 310 / 4  | 310 / 2  | 72   | 18   | 6   | 620   |
| 3  | 26A    | 164    | FRANGILLI, Carla      | ITA | 314 / 2  | 300 / 8  | 72   | 14   | 8   | 614   |
| 4  | 27D    | 140    | GAUTHIER, Gaelle      | FRA | 302 / 7  | 310 / 3  | 72   | 12   | 1   | 612   |
| 5  | 25A    | 166    | LIONETTI, Pia Carmen  | ITA | 313 / 3  | 298 / 12 | 71   | 15   | 4   | 611   |
| 6  | 30B    | 240    | DMYTRIUK, Kateryna    | UKR | 305 / 5  | 303 / 5  | 72   | 15   | 3   | 608   |
| 7  | 29D    | 225    | KNUTSSON, Jennie      | SWE | 291 / 11 | 315 / 1  | 72   | 14   | 3   | 606   |
| 8  | 26C    | 155    | PAVEL, Anne           | GER | 304 / 6  | 299 / 10 | 72   | 14   | 5   | 603   |
| 9  | 25B    | 193    | SZYDLOWSKA, Agnieszka | POL | 300 / 8  | 294 / 15 | 72   | 8    | 1   | 594   |
| 10 | 26B    | 194    | TRZCIONKA, Alicja     | POL | 296 / 9  | 297 / 13 | 72   | 10   | 3   | 593   |
| 11 | 29B    | 247    | KUSHNIRUK, Olena      | UKR | 284 / 17 | 303 / 6  | 72   | 10   | 2   | 587   |
| 12 | 28A    | 233    | BESKEN, Ilke          | TUR | 286 / 16 | 299 / 9  | 72   | 11   | 0   | 585   |
| 13 | 26D    | 139    | FAYE, Sandra          | FRA | 287 / 15 | 293 / 16 | 72   | 12   | 4   | 580   |
| 14 | 31C    | 105    | MARTINERO, Sabrina    | BEL | 287 / 14 | 290 / 19 | 72   | 9    | 2   | 577   |
| 15 | 29A    | 234    | CAKIR, Merve          | TUR | 288 / 13 | 289 / 20 | 70   | 18   | 1   | 577   |
| 16 | 27A    | 169    | TOMASI, Jessica       | ITA | 274 / 24 | 302 / 7  | 71   | 10   | 1   | 576   |
| 17 | 28C    | 196    | DOBLEKAR, Marjana     | SLO | 279 / 18 | 293 / 17 | 71   | 9    | 5   | 572   |
| 18 | 24A    | 165    | FRIGERI, Maura        | ITA | 277 / 20 | 291 / 18 | 71   | 13   | 3   | 568   |
| 19 | 27B    | 186    | NIEMIEC, Izabela      | POL | 272 / 26 | 295 / 14 | 71   | 11   | 2   | 567   |
| 20 | 31B    | 113    | RASKOVA, Hana         | CZE | 292 / 10 | 268 / 28 | 72   | 7    | 3   | 560   |
| 21 | 31A    | 213    | MELICHAROVA, Kristina | SVK | 262 / 28 | 298 / 11 | 71   | 9    | 4   | 560   |
| 22 | 24B    | 188    | NORKOWSKA, Karolina   | POL | 276 / 21 | 283 / 21 | 72   | 3    | 1   | 559   |
| 23 | 27C    | 157    | RIEGER, Deborah       | GER | 275 / 23 | 279 / 22 | 72   | 9    | 3   | 554   |
| 24 | 28B    | 248    | MAZINA, Nataliya      | UKR | 290 / 12 | 262 / 31 | 71   | 8    | 1   | 552   |
| 25 | 28D    | 216    | ALNEFELD, Anna        | SWE | 277 / 19 | 273 / 25 | 71   | 9    | 2   | 550   |
| 26 | 24D    | 137    | BRANLANT, Laure       | FRA | 267 / 27 | 277 / 23 | 72   | 7    | 3   | 544   |
| 27 | 30C    | 204    | NAGODE, Irena         | SLO | 273 / 25 | 267 / 29 | 72   | 6    | 3   | 540   |
| 28 | 30A    | 235    | CESUR, Güllizar       | TUR | 276 / 22 | 263 / 30 | 72   | 7    | 1   | 539   |
| 29 | 25D    | 138    | CHAMBON, Anne         | FRA | 260 / 29 | 275 / 24 | 71   | 6    | 2   | 535   |
| 30 | 30D    | 226    | KRANTZ, Hanna         | SWE | 254 / 30 | 272 / 26 | 72   | 10   | 5   | 526   |
| 31 | 29C    | 197    | GODEC, Maja           | SLO | 247 / 31 | 268 / 27 | 71   | 8    | 5   | 515   |

## Compound Cadet Men

|    | Target | BackNr | Name                  | NOC | 70 m/Rk  | 70 m/Rk  | Hits | 10's | X's | Total |
|----|--------|--------|-----------------------|-----|----------|----------|------|------|-----|-------|
| 1  | 15A    | 118    | DAMSBO, Michael       | DEN | 339 / 1  | 335 / 1  | 72   | 32   | 9   | 674   |
| 2  | 15B    | 205    | OSEP, Aleksander      | SLO | 338 / 2  | 333 / 2  | 72   | 33   | 13  | 671   |
| 3  | 16A    | 123    | LAURSEN, Patrick      | DEN | 327 / 3  | 323 / 4  | 72   | 19   | 7   | 650   |
| 4  | 17C    | 211    | BOROVICKA, Milos      | SVK | 324 / 4  | 321 / 5  | 72   | 22   | 5   | 645   |
| 5  | 15C    | 103    | DURLET, Jean-Philippe | BEL | 324 / 5  | 318 / 8  | 72   | 13   | 3   | 642   |
| 6  | 16B    | 198    | JERIN, Grega          | SLO | 320 / 6  | 318 / 7  | 72   | 22   | 8   | 638   |
| 7  | 17A    | 119    | HUNERSEN, Henrik      | DEN | 317 / 7  | 309 / 10 | 72   | 20   | 5   | 626   |
| 8  | 16C    | 106    | PIETTE, Laurent       | BEL | 305 / 11 | 319 / 6  | 72   | 12   | 2   | 624   |
| 9  | 17D    | 122    | KARST, Martin         | DEN | 300 / 12 | 323 / 3  | 72   | 22   | 6   | 623   |
| 10 | 15D    | 210    | RENSCH, Tom           | SUI | 307 / 10 | 313 / 9  | 72   | 13   | 3   | 620   |
| 11 | 16D    | 171    | ELARTS, Kaspars       | LAT | 313 / 8  | 305 / 11 | 72   | 15   | 3   | 618   |
| 12 | 17B    | 195    | PERHAC, Primož        | SLO | 308 / 9  | 304 / 12 | 72   | 14   | 4   | 612   |

## Compound Cadet Women

|   | Target | BackNr | Name                | NOC | 70 m/Rk | 70 m/Rk | Hits | 10's | X's | Total |
|---|--------|--------|---------------------|-----|---------|---------|------|------|-----|-------|
| 1 | 18A    | 104    | HAEMHOUTS, Petra    | BEL | 314 / 2 | 313 / 1 | 72   | 14   | 4   | 627   |
| 2 | 18D    | 199    | KASE, Meta          | SLO | 317 / 1 | 298 / 3 | 72   | 15   | 3   | 615   |
| 3 | 18B    | 172    | OLEKSEJENKO, Jelena | LAT | 304 / 3 | 304 / 2 | 72   | 19   | 6   | 608   |
| 4 | 18C    | 130    | VEDEL, Anna         | DEN | 291 / 4 | 293 / 4 | 72   | 9    | 2   | 584   |

## Compound Junior Men

|    | Target | BackNr | Name                | NOC | 70 m/Rk  | 70 m/Rk  | Hits | 10's | X's | Total |
|----|--------|--------|---------------------|-----|----------|----------|------|------|-----|-------|
| 1  | 08A    | 117    | DAMSBO, Martin      | DEN | 343 / 1  | 337 / 2  | 72   | 38   | 15  | 680   |
| 2  | 09A    | 115    | ANDERSEN, Andreas   | DEN | 339 / 3  | 334 / 5  | 72   | 29   | 6   | 673   |
| 3  | 10A    | 126    | NOERGAARD, Mads     | DEN | 340 / 2  | 331 / 7  | 72   | 33   | 14  | 671   |
| 4  | 10C    | 207    | RAVNJAK, Urban      | SLO | 338 / 4  | 333 / 6  | 72   | 31   | 12  | 671   |
| 5  | 08B    | 228    | LUNOGREN, Johan     | SWE | 332 / 7  | 338 / 1  | 72   | 30   | 8   | 670   |
| 6  | 08C    | 101    | BEKE, Ludovice      | BEL | 335 / 5  | 334 / 4  | 72   | 33   | 13  | 669   |
| 7  | 10B    | 220    | DANIELSSON, Staffan | SWE | 332 / 6  | 337 / 3  | 72   | 30   | 5   | 669   |
| 8  | 09C    | 107    | VAMDEPOOLE, Mathieu | BEL | 332 / 8  | 325 / 9  | 72   | 21   | 8   | 657   |
| 9  | 09B    | 218    | BOSTROM, Erik       | SWE | 325 / 9  | 330 / 8  | 72   | 25   | 8   | 655   |
| 10 | 08D    | 176    | MASSARD, Edy        | LUX | 314 / 10 | 319 / 10 | 72   | 15   | 5   | 633   |
| 11 | 09D    | 124    | LYKKEBAEK, Martin   | DEN | 298 / 11 | 301 / 11 | 72   | 13   | 3   | 599   |

## Compound Junior Women

|   | Target | BackNr | Name                 | NOC | 70 m/Rk | 70 m/Rk | Hits | 10's | X's | Total |
|---|--------|--------|----------------------|-----|---------|---------|------|------|-----|-------|
| 1 | 12C    | 109    | BUDEN, Ivana         | CRO | 340 / 1 | 343 / 1 | 72   | 38   | 20  | 683   |
| 2 | 11A    | 129    | SOEMOD, Camilla      | DEN | 333 / 2 | 334 / 2 | 72   | 30   | 14  | 667   |
| 3 | 12A    | 125    | MARSLEV, Rikke       | DEN | 332 / 3 | 327 / 4 | 72   | 28   | 8   | 659   |
| 4 | 12B    | 217    | BOBERG, Sara         | SWE | 322 / 6 | 329 / 3 | 72   | 20   | 6   | 651   |
| 5 | 11B    | 219    | DANIELSSON, Isabella | SWE | 323 / 5 | 321 / 5 | 72   | 27   | 4   | 644   |
| 6 | 11C    | 100    | ZECHA, Eva           | AUT | 327 / 4 | 314 / 7 | 72   | 21   | 8   | 641   |
| 7 | 10D    | 120    | HUNERSEN, Laila      | DEN | 316 / 7 | 313 / 8 | 72   | 18   | 5   | 629   |
| 8 | 12D    | 116    | ANDERSEN, Patricia   | DEN | 294 / 9 | 314 / 6 | 71   | 22   | 9   | 608   |
| 9 | 11D    | 224    | JOHANSSON, Caroline  | SWE | 305 / 8 | 300 / 9 | 72   | 14   | 6   | 605   |

Deutscher Schützenbund e.V.  
European Junior Cup 2003 Templin /GER  
von 20.5. - 24.5. 2003



## Team Ranking Results

Recurve Cadet Men

---

### Recurve Cadet Men

| Country | BNr | Name                     | Points | Total       |
|---------|-----|--------------------------|--------|-------------|
| 1 GER   | 24A | 147 FLOTO, Florian       | 652    |             |
|         | 27A | 154 NEUSIUS, Bastian     | 615    |             |
|         | 25A | 159 VENNEMANN, Dennis    | 611    | <b>1878</b> |
|         | 26A | 162 WOLLMANN, Patric     | 575    |             |
| 2 POL   | 24B | 181 GALCZYNSKI, Hubert   | 605    |             |
|         | 26B | 180 DOBRZYNSKI, Jacek    | 605    |             |
|         | 25B | 191 SULEK, Przemyslaw    | 593    | <b>1803</b> |
|         | 27B | 189 RAUK, Tomasz         | 542    |             |
| 3 UKR   | 24C | 249 MIGURA, Artem        | 616    |             |
|         | 25C | 244 HAVELKO, Yuriy       | 590    |             |
|         | 26C | 252 SENIK, Martyn        | 585    | <b>1791</b> |
|         | 27C | 243 DUDNIK, Denys        | 533    |             |
| 4 SWE   | 28D | 222 HENNINGSSON, Jonny   | 581    |             |
|         | 30C | 230 TAPPER, Martin       | 580    |             |
|         | 27D | 223 HJALMASSON, Johannes | 562    | <b>1723</b> |
| 5 LUX   | 24D | 174 DECKER, Gilles       | 611    |             |
|         | 26D | 175 HENCKELS, Jerry      | 578    |             |
|         | 25D | 177 GLESENER, Daniel     | 494    | <b>1683</b> |

---

---

## Recurve Cadet Women

| Country |     | BNr | Name                  | Points | Total       |
|---------|-----|-----|-----------------------|--------|-------------|
| 1 GER   | 19B | 156 | POSSNER, Susanne      | 628    |             |
|         | 20B | 151 | LEVEN, Nadine         | 585    |             |
|         | 21B | 153 | GANSEN, Melanie       | 572    | <b>1785</b> |
|         | 22B | 158 | UNRUH, Lisa           | 566    |             |
| 2 UKR   | 19C | 241 | DOBRYEVA, Halyna      | 597    |             |
|         | 21C | 245 | KALLINICHENKO, Milana | 557    |             |
|         | 20C | 250 | NOVIKOVA, Ityna       | 556    | <b>1710</b> |
| 3 POL   | 21A | 183 | LIPIARSKA, Karina     | 581    |             |
|         | 19A | 187 | NIEMIEC, Ursula       | 567    |             |
|         | 22A | 185 | MIERZWA, Justyna      | 536    | <b>1684</b> |
|         | 20A | 190 | STRZELCZYK, Ena       | 497    |             |

---

---

 Recurve Junior Men

| Country |     | BNr | Name                    | Points | Total       |
|---------|-----|-----|-------------------------|--------|-------------|
| 1 ITA   | 17A | 168 | SCAMMACCA, Ignazio      | 644    |             |
|         | 19A | 163 | ANDERLE, Alessandro     | 636    |             |
|         | 18A | 170 | TONELLI, Amedeo         | 609    | <b>1889</b> |
|         | 20A | 167 | CROCE, Valerio          | 589    |             |
| 2 GER   | 14D | 152 | LUCKE, Tim              | 637    |             |
|         | 15D | 150 | IGGENA, Jan             | 624    |             |
|         | 13D | 148 | GINZEL, Jan-Christoper  | 597    | <b>1858</b> |
|         | 16D | 160 | WIESSE, Lutz            | 582    |             |
| 3 TUR   | 18C | 232 | AGDERE, Bahadir         | 627    |             |
|         | 17C | 237 | KOLAY, Tayfun           | 626    |             |
|         | 19C | 239 | ÖZCELIK, Memmet Ali     | 605    | <b>1858</b> |
| 4 UKR   | 13A | 246 | KRYVOCHENKO, Oleksiy    | 621    |             |
|         | 15A | 242 | DUBAS, Igor             | 619    |             |
|         | 16A | 253 | ZABOLIYAN, Oleksandr    | 611    | <b>1851</b> |
|         | 14A | 251 | PERKOV, Oleksandr       | 609    |             |
| 5 FRA   | 13C | 142 | HELLYNCK, Julien        | 639    |             |
|         | 15C | 145 | VARECHON, Dimitri       | 621    |             |
|         | 14C | 143 | PAYA, Brice             | 585    | <b>1845</b> |
|         | 16C | 146 | VOIRIN, Guillaume       | 583    |             |
| 6 POL   | 18B | 192 | SZOKAL-EGIRD, Krzysztof | 622    |             |
|         | 17B | 184 | MIENKOWSKI, Jerzy       | 609    |             |
|         | 20B | 179 | CIS, Tomasz             | 601    | <b>1832</b> |
|         | 19B | 182 | KOWALSKI, Bartlomiej    | 587    |             |
| 7 SLO   | 23A | 203 | MAZGON, Rok             | 638    |             |
|         | 21A | 206 | POVZ, Matej             | 598    |             |
|         | 22A | 208 | SORLI, Damijan          | 574    | <b>1810</b> |
| 8 DEN   | 18D | 128 | POULSEN, Jacob Rujd     | 605    |             |
|         | 17D | 121 | JAKOBSEN, Franz L.      | 600    |             |
|         | 19D | 127 | PEDERSEN, Kasper S.     | 592    | <b>1797</b> |
| 9 CZE   | 23B | 111 | HLAVA, Alegs            | 612    |             |
|         | 21B | 112 | MIKESKA, Jakub          | 595    |             |
|         | 22B | 114 | TROJAN, Radek           | 556    | <b>1763</b> |
| 10 SWE  | 21C | 229 | OLOFSSON, Martin        | 614    |             |
|         | 20C | 215 | AKESSON, Philip         | 592    |             |
|         | 22C | 231 | THORIN, Cristopher      | 523    | <b>1729</b> |
| 11 EST  | 16B | 136 | SELTTER, Tarmo          | 584    |             |
|         | 13B | 133 | KUKK, Eimar             | 561    |             |
|         | 15B | 131 | EINROOS, Erki           | 517    | <b>1662</b> |
|         | 14B | 132 | KOPPEL, Victor          | 487    |             |

---



---

## Recurve Junior Women

| Country |     | BNr | Name                  | Points | Total       |
|---------|-----|-----|-----------------------|--------|-------------|
| 1 GER   | 24C | 161 | WINTER, Karina        | 623    |             |
|         | 25C | 149 | HILLER, Halina        | 620    |             |
|         | 26C | 155 | PAVEL, Anne           | 603    | <b>1846</b> |
|         | 27C | 157 | RIEGER, Deborah       | 554    |             |
| 2 ITA   | 26A | 164 | FRANGILLI, Carla      | 614    |             |
|         | 25A | 166 | LIONETTI, Pia Carmen  | 611    |             |
|         | 27A | 169 | TOMASI, Jessica       | 576    | <b>1801</b> |
|         | 24A | 165 | FRIGERI, Maura        | 568    |             |
| 3 POL   | 25B | 193 | SZYDLOWSKA, Agnieszka | 594    |             |
|         | 26B | 194 | TRZCIONKA, Alicja     | 593    |             |
|         | 27B | 186 | NIEMIEC, Izabela      | 567    | <b>1754</b> |
|         | 24B | 188 | NORKOWSKA, Karolina   | 559    |             |
| 4 UKR   | 30B | 240 | DMYTRIUK, Kateryna    | 608    |             |
|         | 29B | 247 | KUSHNIRUK, Olena      | 587    |             |
|         | 28B | 248 | MAZINA, Nataliya      | 552    | <b>1747</b> |
| 5 FRA   | 27D | 140 | GAUTHIER, Gaelle      | 612    |             |
|         | 26D | 139 | FAYE, Sandra          | 580    |             |
|         | 24D | 137 | BRANLANT, Laure       | 544    | <b>1736</b> |
|         | 25D | 138 | CHAMBON, Anne         | 535    |             |
| 6 TUR   | 28A | 233 | BESKEN, Ilke          | 585    |             |
|         | 29A | 234 | CAKIR, Merve          | 577    |             |
|         | 30A | 235 | CESUR, Gülizar        | 539    | <b>1701</b> |
| 7 SWE   | 29D | 225 | KNUTSSON, Jennie      | 606    |             |
|         | 28D | 216 | ALNEFELD, Anna        | 550    |             |
|         | 30D | 226 | KRANTZ, Hanna         | 526    | <b>1682</b> |
| 8 SLO   | 28C | 196 | DOBLEKAR, Marjana     | 572    |             |
|         | 30C | 204 | NAGODE, Irena         | 540    |             |
|         | 29C | 197 | GODEC, Maja           | 515    | <b>1627</b> |

## Compound Cadet Men

| Country |     | BNr | Name             | Points | Total       |
|---------|-----|-----|------------------|--------|-------------|
| 1 DEN   | 15A | 118 | DAMSBO, Michael  | 674    |             |
|         | 16A | 123 | LAURSEN, Patrick | 650    |             |
|         | 17A | 119 | HUNERSEN, Henrik | 626    | <b>1950</b> |
|         | 17D | 122 | KARST, Martin    | 623    |             |
| 2 SLO   | 15B | 205 | OSEP, Aleksander | 671    |             |
|         | 16B | 198 | JERIN, Grega     | 638    |             |
|         | 17B | 195 | PERHAC, Primož   | 612    | <b>1921</b> |

---

---

## Compound Junior Men

| Country |     | BNr | Name                | Points | Total       |
|---------|-----|-----|---------------------|--------|-------------|
| 1 DEN   | 8A  | 117 | DAMSBO, Martin      | 680    |             |
|         | 9A  | 115 | ANDERSEN, Andreas   | 673    |             |
|         | 10A | 126 | NOERGAARD, Mads     | 671    | <b>2024</b> |
|         | 9D  | 124 | LYKKEBAEK, Martin   | 599    |             |
| 2 SWE   | 8B  | 228 | LUNOGREN, Johan     | 670    |             |
|         | 10B | 220 | DANIELSSON, Staffan | 669    |             |
|         | 9B  | 218 | BOSTROM, Erik       | 655    | <b>1994</b> |

## Compound Junior Women

| Country |     | BNr | Name                 | Points | Total       |
|---------|-----|-----|----------------------|--------|-------------|
| 1 DEN   | 11A | 129 | SOEMOD, Camilla      | 667    |             |
|         | 12A | 125 | MARSLEV, Rikke       | 659    |             |
|         | 10D | 120 | HUNERSEN, Laila      | 629    | <b>1955</b> |
|         | 12D | 116 | ANDERSEN, Patricia   | 608    |             |
| 2 SWE   | 12B | 217 | BOBERG, Sara         | 651    |             |
|         | 11B | 219 | DANIELSSON, Isabella | 644    |             |
|         | 11D | 224 | JOHANSSON, Caroline  | 605    | <b>1900</b> |

---

# European Junior Cup 2003 Finals

20. - 25. May, Templin /Germany



| Quail. | StNo | Name | Target: 1A           | Land | Res. |
|--------|------|------|----------------------|------|------|
| 1      | 652  | 147  | FLOTO, Florian       | GER  | **   |
| 32     |      |      |                      |      | 0    |
| 17     | 575  | 162  | WOLLMANN, Patric     | GER  | 135  |
| 16     | 578  | 175  | HENCKELS, Jerry      | LUX  | 132  |
| 9      | 605  | 181  | GALCZYNSKI, Hubert   | POL  | 141  |
| 24     | 506  | 214  | ZUBAL, Juraj         | SVK  | 111  |
| 25     | 494  | 177  | GLESENER, Daniel     | LUX  | 143  |
| 8      | 611  | 159  | VENNEMANN, Dennis    | GER  | 157  |
| 5      | 616  | 249  | MIGURA, Artem        | UKR  | **   |
| 28     |      |      |                      |      | 0    |
| 21     | 542  | 189  | RAUK, Tomasz         | POL  | 135  |
| 12     | 590  | 244  | HAVELKO, Yuriy       | UKR  | 149  |
| 13     | 585  | 252  | SENIK, Martyn        | UKR  | 147  |
| 20     | 562  | 223  | HJALMASSON, Johannes | SWE  | 136  |
| 29     |      |      |                      |      | 0    |
| 4      | 620  | 236  | DEMIRKAN, Recep      | TUR  | **   |
| 3      | 623  | 110  | ANDREAS, Milan       | CZE  | **   |
| 30     |      |      |                      |      | 0    |
| 19     | 569  | 212  | GALIK, Martin        | SVK  | 132  |
| 14     | 581  | 222  | HENNINGSSON, Jonny   | SWE  | 129  |
| 11     | 593  | 191  | SULEK, Przemyslaw    | POL  | 130  |
| 22     | 533  | 243  | DUDNIK, Denys        | UKR  | 133  |
| 27     |      |      |                      |      | 0    |
| 6      | 615  | 154  | NEUSIUS, Bastian     | GER  | **   |
| 7      | 611  | 174  | DECKER, Gilles       | LUX  | 136  |
| 26     | 425  | 134  | LINDMAA, Siim        | EST  | 107  |
| 23     | 511  | 202  | MALJEVAC, Josip      | SLO  | 129  |
| 10     | 605  | 180  | DOBRZYNSKI, Jacek    | POL  | 146  |
| 15     | 580  | 230  | TAPPER, Martin       | SWE  | 138  |
| 18     | 574  | 201  | LUKANCIC, Jadran     | SLO  | 142  |
| 31     |      |      |                      |      | 0    |
| 2      | 648  | 141  | GIROULLE, Romain     | FRA  | **   |

1/16 Elim.

1/8 Elim.

Recurve Cadet Men

| Name               | Target: 1A | Land | Res. |
|--------------------|------------|------|------|
| FLOTO, Florian     | GER        | 158  |      |
| WOLLMANN, Patric   | GER        | 140  |      |
| GALCZYNSKI, Hubert | POL        | 147  |      |
| VENNEMANN, Dennis  | GER        | 161  |      |
| MIGURA, Artem      | UKR        | 153  |      |
| HAVELKO, Yuriy     | UKR        | 141  |      |
| SENIK, Martyn      | UKR        | 139  |      |
| DEMIRKAN, Recep    | TUR        | 144  |      |
| ANDREAS, Milan     | CZE        | 151  |      |
| GALIK, Martin      | SVK        | 142  |      |
| DUDNIK, Denys      | UKR        | 138  |      |
| NEUSIUS, Bastian   | GER        | 143  |      |
| DECKER, Gilles     | LUX        | 141  |      |
| DOBRZYNSKI, Jacek  | POL        | 141  |      |
| LUKANCIC, Jadran   | SLO        | 143  |      |
| GIROULLE, Romain   | FRA        | 152  |      |

| Name              | Target: 1 | Land | Res. |
|-------------------|-----------|------|------|
| FLOTO, Florian    | GER       | 106  |      |
| VENNEMANN, Dennis | GER       | 100  |      |
| MIGURA, Artem     | UKR       | 99   |      |
| DEMIRKAN, Recep   | TUR       | 93   |      |
| ANDREAS, Milan    | CZE       | 103  |      |
| NEUSIUS, Bastian  | GER       | 90   |      |
| DECKER, Gilles    | LUX       | 104  |      |
| GIROULLE, Romain  | FRA       | 107  |      |

| Name             | Target: 5 | Land | Res. |
|------------------|-----------|------|------|
| FLOTO, Florian   | GER       | 104  |      |
| MIGURA, Artem    | UKR       | 105  |      |
| GIROULLE, Romain | FRA       | 104  |      |
| MIGURA, Artem    | UKR       | 102  |      |
| ANDREAS, Milan   | CZE       | 100  |      |
| GIROULLE, Romain | FRA       | 101  |      |

**Final**  
1st and 2nd place

**Final**  
3rd and 4th place

1/2 Final

1/4 Final

| Name             | Target: 7 | Land | Res. |
|------------------|-----------|------|------|
| GIROULLE, Romain | FRA       | 104  |      |
| MIGURA, Artem    | UKR       | 102  |      |
| FLOTO, Florian   | GER       | 97   |      |
| ANDREAS, Milan   | CZE       | 94   |      |

1st Place  
2nd Place

3rd Place  
4th Place

Final

# European Junior Cup 2003 Finals

20. - 25. May, Templin /Germany

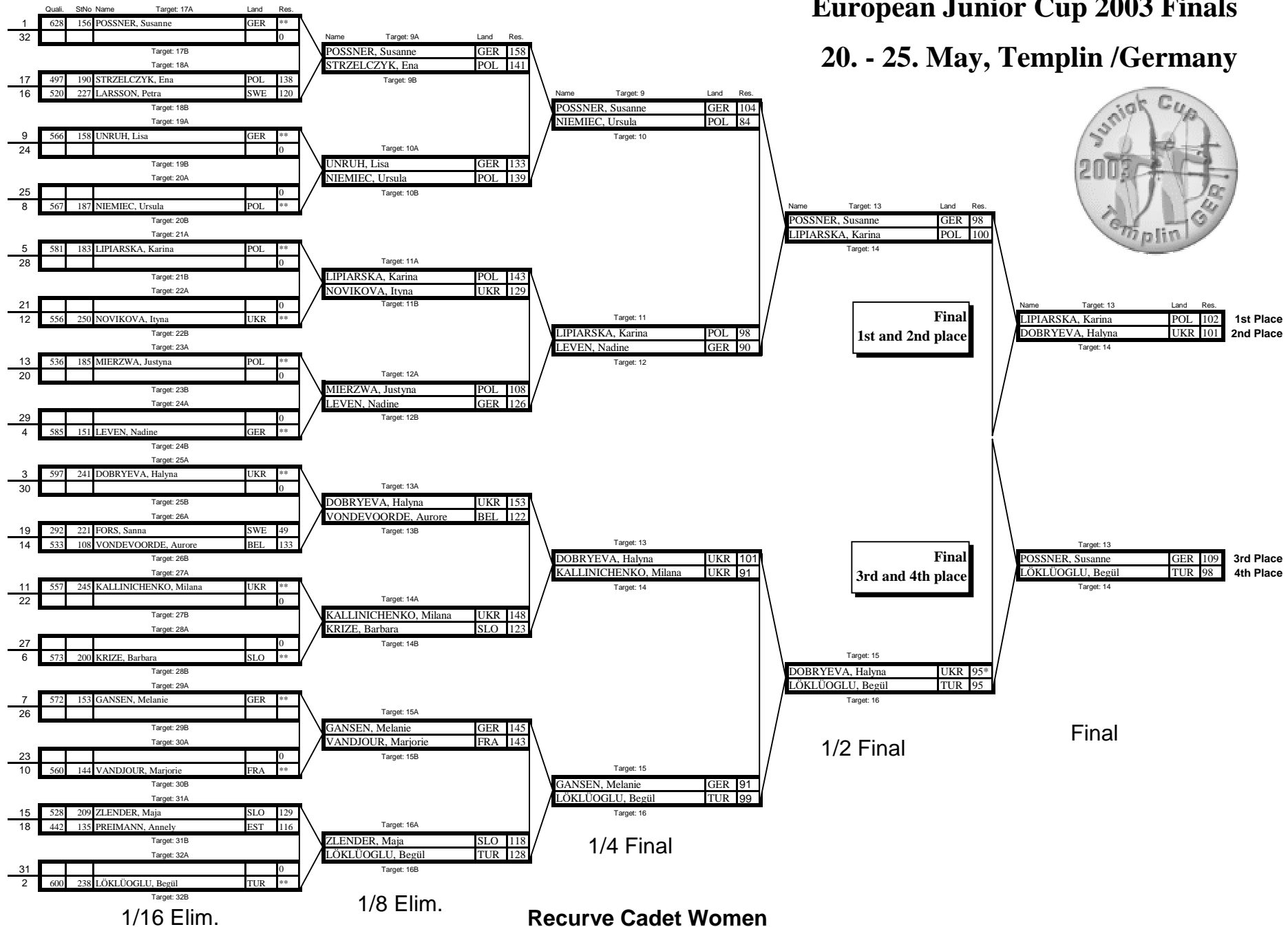

# European Junior Cup 2003

## 20. - 25. May in Templin /GER



|             |   |                          |
|-------------|---|--------------------------|
| Target: 17A |   |                          |
| 1           | <b>DAMSBO, Michael</b><br>DENMARK       | **<br>674 Quali.         |
| 16          |   | Quali.                   |
| Target: 17B |   |                          |
| Target: 18A |   |                          |
| 9           | <b>KARST, Martin</b><br>DENMARK         | <b>156</b><br>623 Quali. |
| 8           | <b>PIETTE, Laurent</b><br>BELGIUM       | <b>158</b><br>624 Quali. |
| Target: 18B |   |                          |
| Target: 19A |   |                          |
| 5           | <b>DURLET, Jean-Philippe</b><br>BELGIUM | <b>155</b><br>642 Quali. |
| 12          | <b>PERHAC, Primoz</b><br>SLOVENIA       | <b>153</b><br>612 Quali. |
| Target: 19B |   |                          |
| Target: 20A |   |                          |
| 13          |   | Quali.                   |
| 4           | <b>BOROVICKA, Milos</b><br>SLOVAKIA     | **<br>645 Quali.         |
| Target: 20B |   |                          |
| Target: 21A |   |                          |
| 3           | <b>LAURSEN, Patrick</b><br>DENMARK      | **<br>650 Quali.         |
| 14          |   | Quali.                   |
| Target: 21B |   |                          |
| Target: 22A |   |                          |
| 11          | <b>ELARTS, Kaspars</b><br>LATVIA        | <b>165</b><br>618 Quali. |
| 6           | <b>JERIN, Grega</b><br>SLOVENIA         | <b>153</b><br>638 Quali. |
| Target: 22B |   |                          |
| Target: 23A |   |                          |
| 7           | <b>HUNERSEN, Henrik</b><br>DENMARK      | <b>147</b><br>626 Quali. |
| 10          | <b>RENSCH, Tom</b><br>SWITZERLAND       | <b>142</b><br>620 Quali. |
| Target: 23B |   |                          |
| Target: 24A |   |                          |
| 15          |   | Quali.                   |
| 2           | <b>OSEP, Aleksander</b><br>SLOVENIA     | **<br>671 Quali.         |
| Target: 24B |   |                          |

|                                   |            |
|-----------------------------------|------------|
| Target: 17                        |            |
| <b>DAMSBO, Michael</b><br>DENMARK | <b>114</b> |
| <b>PIETTE, Laurent</b><br>BELGIUM | <b>100</b> |

|   |            |
|---|------------|
| Target: 18                              |            |
| <b>DAMSBO, Michael</b><br>DENMARK       | <b>112</b> |
| <b>DURLET, Jean-Philippe</b><br>BELGIUM | <b>111</b> |

|   |            |
|---|------------|
| Target: 19                              |            |
| <b>DURLET, Jean-Philippe</b><br>BELGIUM | <b>108</b> |
| <b>BOROVICKA, Milos</b><br>SLOVAKIA     | <b>100</b> |

|                                    |            |
|------------------------------------|------------|
| Target: 20                         |            |
| <b>LAURSEN, Patrick</b><br>DENMARK | <b>110</b> |
| <b>ELARTS, Kaspars</b><br>LATVIA   | <b>107</b> |

|                                     |            |
|-------------------------------------|------------|
| Target: 21                          |            |
| <b>LAURSEN, Patrick</b><br>DENMARK  | <b>112</b> |
| <b>OSEP, Aleksander</b><br>SLOVENIA | <b>101</b> |

|                                     |            |
|-------------------------------------|------------|
| Target: 22                          |            |
| <b>HUNERSEN, Henrik</b><br>DENMARK  | <b>89</b>  |
| <b>OSEP, Aleksander</b><br>SLOVENIA | <b>108</b> |

|                                     |            |
|-------------------------------------|------------|
| Target: 23                          |            |
| <b>LAURSEN, Patrick</b><br>DENMARK  | <b>112</b> |
| <b>OSEP, Aleksander</b><br>SLOVENIA | <b>101</b> |

|   |            |
|---|------------|
| Target: 24                              |            |
| <b>LAURSEN, Patrick</b><br>DENMARK      | <b>109</b> |
| <b>DURLET, Jean-Philippe</b><br>BELGIUM | <b>109</b> |
| <b>OSEP, Aleksander</b><br>SLOVENIA     | <b>106</b> |

|                                    |            |
|------------------------------------|------------|
| Target: 19                         |            |
| <b>LAURSEN, Patrick</b><br>DENMARK | <b>112</b> |
| <b>DAMSBO, Michael</b><br>DENMARK  | <b>109</b> |

|   |            |
|---|------------|
| Target: 20                              |            |
| <b>DURLET, Jean-Philippe</b><br>BELGIUM | <b>109</b> |
| <b>OSEP, Aleksander</b><br>SLOVENIA     | <b>106</b> |

|                                    |            |
|------------------------------------|------------|
| Target: 20                         |            |
| <b>LAURSEN, Patrick</b><br>DENMARK | <b>112</b> |
| <b>DAMSBO, Michael</b><br>DENMARK  | <b>109</b> |

**1/8 Elim.**

**1/4 Final**

**1/2 Final**

**Final**  
1st and 2nd place

**Final**  
3rd and 4th place

\* = Won in shootout

Compound Cadet Men

# European Junior Cup 2003

## 20. - 25. May, in Templin /GER



Target: 29

|   |                         |            |        |
|---|-------------------------|------------|--------|
|   | <b>HAEMHOUTS, Petra</b> | <b>99</b>  |        |
| 1 | BELGIUM                 | 627        | Quali. |
|   | <b>VEDEL, Anna</b>      | <b>100</b> |        |
| 4 | DENMARK                 | 584        | Quali. |

Target: 30

**Final**  
1st and 2nd place

Target: 25

|                            |            |           |
|----------------------------|------------|-----------|
| <b>VEDEL, Anna</b>         | <b>108</b> | 1st Place |
| DENMARK                    |            |           |
| <b>OLEKSEJENKO, Jelena</b> | <b>96</b>  | 2nd Place |
| LATVIA                     |            |           |

Target: 26

**Final**  
3rd and 4th place

Target: 25

|                         |            |           |
|-------------------------|------------|-----------|
| <b>HAEMHOUTS, Petra</b> | <b>102</b> | 3rd Place |
| BELGIUM                 |            |           |
| <b>KASE, Meta</b>       | <b>87</b>  | 4th Place |
| SLOVENIA                |            |           |

Target: 26

**Final**

Target: 31

|   |                            |           |        |
|---|----------------------------|-----------|--------|
|   | <b>KASE, Meta</b>          | <b>54</b> |        |
| 2 | SLOVENIA                   | 615       | Quali. |
|   | <b>OLEKSEJENKO, Jelena</b> | <b>99</b> |        |
| 3 | LATVIA                     | 608       | Quali. |

Target: 32

**1/2 Final**

**Compound Cadet Women**

\* = Won in shootout

# European Junior Cup 2003 Final Results

FITA Olympic Round

20. - 25. May, 2003 Templin /Germany

## Recurve Cadet Men

| Pl. | Name                | Nation         | Quali. | 1/16 | 1/8 | 1/4 | 1/2 | Final |
|-----|---------------------|----------------|--------|------|-----|-----|-----|-------|
| 1   | GIROULLE, Romain    | FRANCE         | 648    | **   | 152 | 107 | 101 | 104   |
| 2   | MIGURA, Artem       | UKRAINE        | 616    | **   | 153 | 99  | 105 | 102   |
| 3   | FLOTO, Florian      | GERMANY        | 652    | **   | 158 | 106 | 104 | 97    |
| 4   | ANDREAS, Milan      | CZECH REPUBLIC | 623    | **   | 151 | 103 | 100 | 94    |
| 5   | DECKER, Gilles      | LUXEMBOURG     | 611    | 136  | 141 | 104 |     |       |
| 6   | VENNEMANN, Dennis   | GERMANY        | 611    | 157  | 161 | 100 |     |       |
| 7   | DEMIRKAN, Recep     | TURKEY         | 620    | **   | 144 | 93  |     |       |
| 8   | NEUSIUS, Bastian    | GERMANY        | 615    | **   | 143 | 90  |     |       |
| 9   | GALCZYNSKI, Hubert  | POLAND         | 605    | 141  | 147 |     |     |       |
| 10  | LUKANCIC, Jadran    | SLOVENIA       | 574    | 142  | 143 |     |     |       |
| 11  | GALIK, Martin       | SLOVAKIA       | 569    | 132  | 142 |     |     |       |
| 12  | HAVELKO, Yuriy      | UKRAINE        | 590    | 149  | 141 |     |     |       |
| 12  | DOBRZYNSKI, Jacek   | POLAND         | 605    | 146  | 141 |     |     |       |
| 14  | WOLLMANN, Patric    | GERMANY        | 575    | 135  | 140 |     |     |       |
| 15  | SENIK, Martyn       | UKRAINE        | 585    | 147  | 139 |     |     |       |
| 16  | DUDNIK, Denys       | UKRAINE        | 533    | 133  | 138 |     |     |       |
| 17  | GLESENER, Daniel    | LUXEMBOURG     | 494    | 143  |     |     |     |       |
| 18  | TAPPER, Martin      | SWEDEN         | 580    | 138  |     |     |     |       |
| 19  | HJALMASSON, Johanne | SWEDEN         | 562    | 136  |     |     |     |       |
| 20  | RAUK, Tomasz        | POLAND         | 542    | 135  |     |     |     |       |
| 21  | HENCKELS, Jerry     | LUXEMBOURG     | 578    | 132  |     |     |     |       |
| 22  | SULEK, Przemyslaw   | POLAND         | 593    | 130  |     |     |     |       |
| 23  | HENNINGSSON, Jonny  | SWEDEN         | 581    | 129  |     |     |     |       |
| 23  | MALJEVAC, Josip     | SLOVENIA       | 511    | 129  |     |     |     |       |
| 25  | ZUBAL, Juraj        | SLOVAKIA       | 506    | 111  |     |     |     |       |
| 26  | LINDMAA, Siim       | ESTONIA        | 425    | 107  |     |     |     |       |

# European Junior Cup 2003 Final Results

20. - 25. May, 2003 Templin /Germany

FITA Olympic Round

## Recurve Cadet Women

| Rg. | Name                | Nation   | Quali. | 1/16 | 1/8 | 1/4 | 1/2 | Final |
|-----|---------------------|----------|--------|------|-----|-----|-----|-------|
| 1   | LIPIARSKA, Karina   | POLAND   | 581    | **   | 143 | 98  | 100 | 102   |
| 2   | DOBRYEVA, Halyna    | UKRAINE  | 597    | **   | 153 | 101 | 95* | 101   |
| 3   | POSSNER, Susanne    | GERMANY  | 628    | **   | 158 | 104 | 98  | 109   |
| 4   | LÖKLÜOĞLU, Begül    | TURKEY   | 600    | **   | 128 | 99  | 95  | 98    |
| 5   | KALLINICHENKO, Mila | UKRAINE  | 557    | **   | 148 | 91  |     |       |
| 5   | GANSEN, Melanie     | GERMANY  | 572    | **   | 145 | 91  |     |       |
| 7   | LEVEN, Nadine       | GERMANY  | 585    | **   | 126 | 90  |     |       |
| 8   | NIEMIEC, Ursula     | POLAND   | 567    | **   | 139 | 84  |     |       |
| 9   | VANDJOUR, Marjorie  | FRANCE   | 560    | **   | 143 |     |     |       |
| 10  | STRZELCZYK, Ena     | POLAND   | 497    | 138  | 141 |     |     |       |
| 11  | UNRUH, Lisa         | GERMANY  | 566    | **   | 133 |     |     |       |
| 12  | NOVIKOVA, Ityna     | UKRAINE  | 556    | **   | 129 |     |     |       |
| 13  | KRIZE, Barbara      | SLOVENIA | 573    | **   | 123 |     |     |       |
| 14  | VONDEVOORDE, Aureo  | BELGIUM  | 533    | 133  | 122 |     |     |       |
| 15  | ZLENDER, Maja       | SLOVENIA | 528    | 129  | 118 |     |     |       |
| 16  | MIERZWA, Justyna    | POLAND   | 536    | **   | 108 |     |     |       |
| 17  | LARSSON, Petra      | SWEDEN   | 520    | 120  |     |     |     |       |
| 18  | PREIMANN, Annely    | ESTONIA  | 442    | 116  |     |     |     |       |
| 19  | FORS, Sanna         | SWEDEN   | 292    | 49   |     |     |     |       |



# European Junior Cup 2003 /Final Results

20. - 25. May, Templin /GER

FITA Olympic Round

## Compound Cadet Men

| Pl. | Name                  | Nation      | Quali. | 1/8 | 1/4 | 1/2 | Final |
|-----|-----------------------|-------------|--------|-----|-----|-----|-------|
| 1   | LAURSEN, Patrick      | DENMARK     | 650    | **  | 110 | 112 | 112   |
| 2   | DAMSBO, Michael       | DENMARK     | 674    | **  | 114 | 112 | 109   |
| 3   | DURLET, Jean-Philippe | BELGIUM     | 642    | 155 | 108 | 111 | 109   |
| 4   | OSEP, Aleksander      | SLOVENIA    | 671    | **  | 108 | 101 | 106   |
| 5   | ELARTS, Kaspars       | LATVIA      | 618    | 165 | 107 |     |       |
| 6   | PIETTE, Laurent       | BELGIUM     | 624    | 158 | 100 |     |       |
| 6   | BOROVICKA, Milos      | SLOVAKIA    | 645    | **  | 100 |     |       |
| 8   | HUNERSEN, Henrik      | DENMARK     | 626    | 147 | 89  |     |       |
| 9   | KARST, Martin         | DENMARK     | 623    | 156 |     |     |       |
| 10  | PERHAC, Primoz        | SLOVENIA    | 612    | 153 |     |     |       |
| 10  | JERIN, Grega          | SLOVENIA    | 638    | 153 |     |     |       |
| 11  | RENSCH, Tom           | SWITZERLAND | 620    | 142 |     |     |       |

# European Junior Cup 2003 /Final Results

FITA Olympic Round

20. - 25. May, Templin /GER

## Compound Cadet Women

| Pl. | Name                | Nation   | Quali. | 1/2 | Final |
|-----|---------------------|----------|--------|-----|-------|
| 1   | VEDEL, Anna         | DENMARK  | 584    | 100 | 108   |
| 2   | OLEKSEJENKO, Jelena | LATVIA   | 608    | 99  | 96    |
| 3   | HAEMHOUTS, Petra    | BELGIUM  | 627    | 99  | 102   |
| 4   | KASE, Meta          | SLOVENIA | 615    | 54  | 87    |

# European Junior Cup 2003 Finals

## 20. - 25. May 2003 Templin /GER

| Tar. | Quali. | StNo | Name | Land                    | Score | Name | Target: 1A              | Land | Score |
|------|--------|------|------|-------------------------|-------|------|-------------------------|------|-------|
| 1A   | 1      | 644  | 168  | SCAMMACCA, Ignazio      | ITA   | **   | SCAMMACCA, Ignazio      | ITA  | 143   |
| 1B   | 64     |      |      |                         |       |      |                         |      |       |
| 2A   | 33     | 584  | 136  | SELTER, Tarmo           | EST   | 115  | PAYA, Brice             | FRA  | 140   |
| 2B   | 32     | 585  | 143  | PAYA, Brice             | FRA   | 132  |                         |      |       |
| 3A   | 17     | 609  | 170  | TONELLI, Amedeo         | ITA   | **   | SCAMMACCA, Ignazio      | ITA  | 154   |
| 3B   | 48     |      |      |                         |       |      | TONELLI, Amedeo         | ITA  | 138   |
| 4A   | 49     |      |      |                         |       |      |                         |      |       |
| 4B   | 16     | 609  | 251  | PERKOV, Oleksandr       | UKR   | **   | TONELLI, Amedeo         | ITA  | 159   |
| 5A   | 9      | 622  | 192  | SZOKAL-EGIRD, Krzysztof | POL   | **   | PERKOV, Oleksandr       | UKR  | 135   |
| 5B   | 56     |      |      |                         |       |      |                         |      |       |
| 6A   | 41     | 487  | 132  | KOPPEL, Victor          | EST   | 118  | SZOKAL-EGIRD, Krzysztof | POL  | 163   |
| 6B   | 24     | 599  | 178  | VASAUNE, David          | LUX   | 142  | VASAUNE, David          | LUX  | 151   |
| 7A   | 25     | 598  | 206  | POVZ, Matej             | SLO   | 137  |                         |      |       |
| 7B   | 40     | 517  | 131  | EINROOS, Erki           | EST   | 138  | SZOKAL-EGIRD, Krzysztof | POL  | 154   |
| 8A   | 57     |      |      |                         |       |      | IGGENA, Jan             | GER  | 144   |
| 8B   | 8      | 624  | 150  | IGGENA, Jan             | GER   | **   |                         |      |       |
| 9A   | 5      | 636  | 163  | ANDERLE, Alessandro     | ITA   | **   |                         |      |       |
| 9B   | 60     |      |      |                         |       |      |                         |      |       |
| 10A  | 37     | 561  | 133  | KUKK, Eimar             | EST   | 138  | ANDERLE, Alessandro     | ITA  | 153   |
| 10B  | 28     | 592  | 127  | PEDERSEN, Kasper S.     | DEN   | 147  | PEDERSEN, Kasper S.     | DEN  | 134   |
| 11A  | 21     | 603  | 102  | DE WACHTER, Kristof     | BEL   | **   | ANDERLE, Alessandro     | ITA  | 143   |
| 11B  | 44     |      |      |                         |       |      | DUBAS, Igor             | UKR  | 153   |
| 12A  | 53     |      |      |                         |       |      |                         |      |       |
| 12B  | 12     | 619  | 242  | DUBAS, Igor             | UKR   | **   | DE WACHTER, Kristof     | BEL  | 150   |
| 13A  | 13     | 614  | 229  | OLOFSSON, Martin        | SWE   | **   | DUBAS, Igor             | UKR  | 160   |
| 13B  | 52     |      |      |                         |       |      |                         |      |       |
| 14A  | 45     |      |      |                         |       |      |                         |      |       |
| 14B  | 20     | 605  | 239  | ÖZCELİK, Memmet Ali     | TUR   | **   | OLOFSSON, Martin        | SWE  | 157   |
| 15A  | 29     | 592  | 215  | AKESSON, Philip         | SWE   | 144  | ÖZCELİK, Memmet Ali     | TUR  | 138   |
| 15B  | 36     | 574  | 208  | SORLI, Damijan          | SLO   | 137  |                         |      |       |
| 16A  | 61     |      |      |                         |       |      |                         |      |       |
| 16B  | 4      | 637  | 152  | LUCKE, Tim              | GER   | **   | AKESSON, Philip         | SWE  | 151   |
| 17A  | 3      | 638  | 203  | MAZGON, Rok             | SLO   | **   | LUCKE, Tim              | GER  | 164   |
| 17B  | 62     |      |      |                         |       |      |                         |      |       |
| 18A  | 35     | 582  | 160  | WIESSE, Lutz            | GER   | 146  |                         |      |       |
| 18B  | 30     | 589  | 167  | CROCE, Valerio          | ITA   | 135  |                         |      |       |
| 19A  | 19     | 605  | 128  | POULSEN, Jacob Rujd     | DEN   | **   |                         |      |       |
| 19B  | 46     |      |      |                         |       |      |                         |      |       |
| 20A  | 51     |      |      |                         |       |      |                         |      |       |
| 20B  | 14     | 612  | 111  | HLAVA, Alegs            | CZE   | **   |                         |      |       |
| 21A  | 11     | 621  | 246  | KRYVOCHENKO, Oleksiy    | UKR   | **   |                         |      |       |
| 21B  | 54     |      |      |                         |       |      |                         |      |       |
| 22A  | 43     |      |      |                         |       |      |                         |      |       |
| 22B  | 22     | 601  | 179  | CIS, Tomasz             | POL   | **   |                         |      |       |
| 23A  | 27     | 595  | 112  | MIKESKA, Jakub          | CZE   | 149  |                         |      |       |
| 23B  | 38     | 556  | 114  | TROJAN, Radek           | CZE   | 142  |                         |      |       |
| 24A  | 59     |      |      |                         |       |      |                         |      |       |
| 24B  | 6      | 627  | 232  | AGDERE, Bahadir         | TUR   | **   |                         |      |       |
| 25A  | 7      | 626  | 237  | KOLAY, Tayfun           | TUR   | **   |                         |      |       |
| 25B  | 58     |      |      |                         |       |      |                         |      |       |
| 26A  | 39     | 523  | 231  | THORIN, Cristopher      | SWE   | 138  |                         |      |       |
| 26B  | 26     | 597  | 148  | GINZEL, Jan-Christoper  | GER   | 148  |                         |      |       |
| 27A  | 23     | 600  | 121  | JAKOBSEN, Franz L.      | DEN   | **   |                         |      |       |
| 27B  | 42     |      |      |                         |       |      |                         |      |       |
| 28A  | 55     |      |      |                         |       |      |                         |      |       |
| 28B  | 10     | 621  | 145  | VARECHON, Dimitri       | FRA   | **   |                         |      |       |
| 29A  | 15     | 611  | 253  | ZABOLIYAN, Oleksandr    | UKR   | **   |                         |      |       |
| 29B  | 60     | 0    | 0    |                         |       |      |                         |      |       |
| 30A  | 47     |      |      |                         |       |      |                         |      |       |
| 30B  | 18     | 609  | 184  | MIENKOWSKI, Jerzy       | POL   | **   |                         |      |       |
| 31A  | 31     | 587  | 182  | KOWALSKI, Bartlomiej    | POL   | 142  |                         |      |       |
| 31B  | 34     | 583  | 146  | VOIRIN, Guillaume       | FRA   | 146  |                         |      |       |
| 32A  | 63     |      |      |                         |       |      |                         |      |       |
| 32B  | 2      | 639  | 142  | HELLYNCK, Julien        | FRA   | **   |                         |      |       |

| Name                    | Target: 1A | Land | Score |
|-------------------------|------------|------|-------|
| SCAMMACCA, Ignazio      | ITA        | 143  |       |
| PAYA, Brice             | FRA        | 140  |       |
| SCAMMACCA, Ignazio      | ITA        | 154  |       |
| TONELLI, Amedeo         | ITA        | 138  |       |
| TONELLI, Amedeo         | ITA        | 159  |       |
| PERKOV, Oleksandr       | UKR        | 135  |       |
| SZOKAL-EGIRD, Krzysztof | POL        | 163  |       |
| VASAUNE, David          | LUX        | 151  |       |
| SZOKAL-EGIRD, Krzysztof | POL        | 154  |       |
| IGGENA, Jan             | GER        | 144  |       |
| EINROOS, Erki           | EST        | 150  |       |
| IGGENA, Jan             | GER        | 166  |       |
| ANDERLE, Alessandro     | ITA        | 153  |       |
| PEDERSEN, Kasper S.     | DEN        | 134  |       |
| ANDERLE, Alessandro     | ITA        | 143  |       |
| DUBAS, Igor             | UKR        | 153  |       |
| DE WACHTER, Kristof     | BEL        | 150  |       |
| DUBAS, Igor             | UKR        | 160  |       |
| OLOFSSON, Martin        | SWE        | 157  |       |
| ÖZCELİK, Memmet Ali     | TUR        | 138  |       |
| ÖZCELİK, Memmet Ali     | TUR        | 138  |       |
| AKESSON, Philip         | SWE        | 144  |       |
| LUCKE, Tim              | GER        | 146  |       |
| AKESSON, Philip         | SWE        | 151  |       |
| LUCKE, Tim              | GER        | 164  |       |
| MAZGON, Rok             | SLO        | 156  |       |
| WIESSE, Lutz            | GER        | 160  |       |
| WIESSE, Lutz            | GER        | 151  |       |
| POULSEN, Jacob Rujd     | DEN        | 152  |       |
| POULSEN, Jacob Rujd     | DEN        | 158  |       |
| HLAVA, Alegs            | CZE        | 151  |       |
| KRYVOCHENKO, Oleksiy    | UKR        | 160  |       |
| CIS, Tomasz             | POL        | 139  |       |
| KRYVOCHENKO, Oleksiy    | UKR        | 162  |       |
| AGDERE, Bahadir         | TUR        | 153  |       |
| MIKESKA, Jakub          | CZE        | 152  |       |
| AGDERE, Bahadir         | TUR        | 153  |       |
| KOLAY, Tayfun           | TUR        | 152  |       |
| GINZEL, Jan-Christoper  | GER        | 150  |       |
| KOLAY, Tayfun           | TUR        | 150  |       |
| JAKOBSEN, Franz L.      | DEN        | 143  |       |
| JAKOBSEN, Franz L.      | DEN        | 157  |       |
| VARECHON, Dimitri       | FRA        | 146  |       |
| KOLAY, Tayfun           | TUR        | 106  |       |
| HELLYNCK, Julien        | FRA        | 108  |       |
| ZABOLIYAN, Oleksandr    | UKR        | 157  |       |
| MIENKOWSKI, Jerzy       | POL        | 150  |       |
| ZABOLIYAN, Oleksandr    | UKR        | 153  |       |
| HELLYNCK, Julien        | FRA        | 153* |       |
| MIENKOWSKI, Jerzy       | POL        | 150  |       |
| KOWALSKI, Bartlomiej    | POL        | 142  |       |
| VOIRIN, Guillaume       | FRA        | 147  |       |
| HELLYNCK, Julien        | FRA        | 162  |       |

| Name                    | Target: 1 | Land | Score |
|-------------------------|-----------|------|-------|
| SCAMMACCA, Ignazio      | ITA       | 101  |       |
| SZOKAL-EGIRD, Krzysztof | POL       | 95   |       |
| SCAMMACCA, Ignazio      | ITA       | 102  |       |
| LUCKE, Tim              | GER       | 101  |       |
| DUBAS, Igor             | UKR       | 99   |       |
| LUCKE, Tim              | GER       | 106  |       |
| DUBAS, Igor             | UKR       | 99   |       |
| LUCKE, Tim              | GER       | 106  |       |
| OLOFSSON, Martin        | SWE       | 145  |       |
| LUCKE, Tim              | GER       | 146  |       |
| WIESSE, Lutz            | GER       | 151  |       |
| POULSEN, Jacob Rujd     | DEN       | 152  |       |
| POULSEN, Jacob Rujd     | DEN       | 89   |       |
| KRYVOCHENKO, Oleksiy    | UKR       | 102  |       |
| KRYVOCHENKO, Oleksiy    | UKR       | 99   |       |
| AGDERE, Bahadir         | TUR       | 153  |       |
| AGDERE, Bahadir         | TUR       | 153  |       |
| KOLAY, Tayfun           | TUR       | 150  |       |
| JAKOBSEN, Franz L.      | DEN       | 143  |       |
| KOLAY, Tayfun           | TUR       | 106  |       |
| HELLYNCK, Julien        | FRA       | 108  |       |
| ZABOLIYAN, Oleksandr    | UKR       | 157  |       |
| MIENKOWSKI, Jerzy       | POL       | 150  |       |
| ZABOLIYAN, Oleksandr    | UKR       | 153  |       |
| HELLYNCK, Julien        | FRA       | 153* |       |
| MIENKOWSKI, Jerzy       | POL       | 150  |       |
| KOWALSKI, Bartlomiej    | POL       | 142  |       |
| VOIRIN, Guillaume       | FRA       | 147  |       |
| HELLYNCK, Julien        | FRA       | 162  |       |

| Name                 | Target: 6 | Land | Score |
|----------------------|-----------|------|-------|
| SCAMMACCA, Ignazio   | ITA       | 102  |       |
| LUCKE, Tim           | GER       | 101  |       |
| HELLYNCK, Julien     | FRA       | 107  |       |
| SCAMMACCA, Ignazio   | ITA       | 105  |       |
| HELLYNCK, Julien     | FRA       | 107  |       |
| SCAMMACCA, Ignazio   | ITA       | 105  |       |
| KRYVOCHENKO, Oleksiy | UKR       | 99   |       |
| LUCKE, Tim           | GER       | 97   |       |
| KRYVOCHENKO, Oleksiy | UKR       | 99   |       |
| HELLYNCK, Julien     | FRA       | 97   |       |
| KRYVOCHENKO, Oleksiy | UKR       | 99   |       |
| HELLYNCK, Julien     | FRA       | 108  |       |

1/32 Elim.      1/16 Elim.      1/8 Elim.      1/4 Final      1/2 Final      Final

**Recurve Junior Men**

**Recurve Junior Men**

**Final**  
1st and 2nd place

**Final**  
3rd and 4th place

**1st Place**  
**2nd Place**

**3rd Place**  
**4th Place**

# European Junior Cup 2003 Finals

20. - 25. May, 2003 Templin /GER

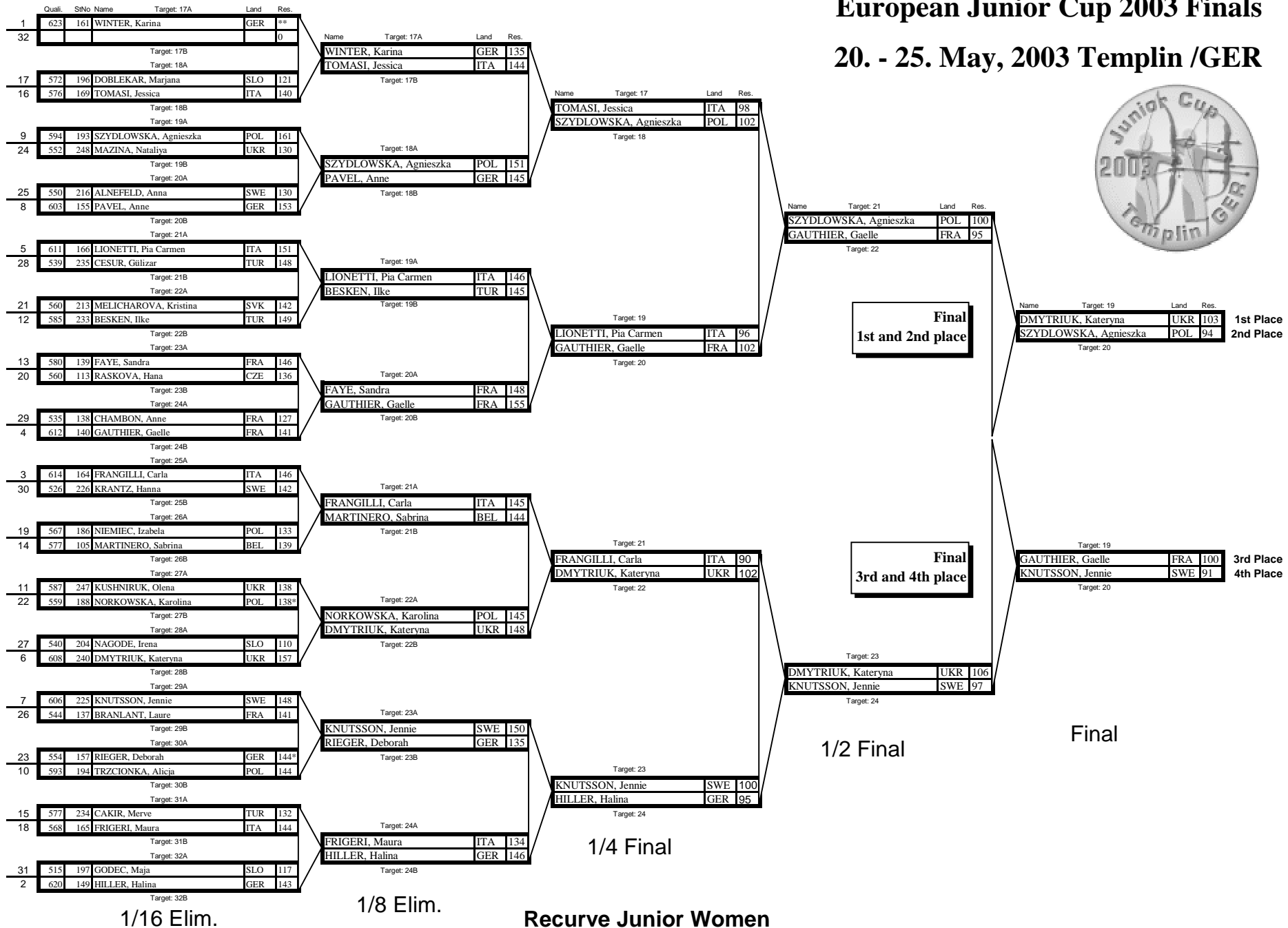

**European Junior Cup 2003 Finals**  
20. - 25. May, Templin /Germany



|             |                                       |                          |
|-------------|---------------------------------------|--------------------------|
| Target: 9A  |                                       |                          |
| 1           | <b>DAMSBO, Martin</b><br>DENMARK      | **<br>680 Quali.         |
| 16          |                                       | Quali.                   |
| Target: 9B  |                                       |                          |
| Target: 10A |                                       |                          |
| 9           | <b>BOSTROM, Erik</b><br>SWEDEN        | <b>160</b><br>655 Quali. |
| 8           | <b>VAMDEPOOLE, Mathieu</b><br>BELGIUM | <b>161</b><br>657 Quali. |
| Target: 10B |                                       |                          |
| Target: 11A |                                       |                          |
| 5           | <b>LUNOGREN, Johan</b><br>SWEDEN      | **<br>670 Quali.         |
| 12          |                                       | Quali.                   |
| Target: 11B |                                       |                          |
| Target: 12A |                                       |                          |
| 13          |                                       | Quali.                   |
| 4           | <b>RAVNJAK, Urban</b><br>SLOVENIA     | **<br>671 Quali.         |
| Target: 12B |                                       |                          |
| Target: 13A |                                       |                          |
| 3           | <b>NOERGAARD, Mads</b><br>DENMARK     | **<br>671 Quali.         |
| 14          |                                       | Quali.                   |
| Target: 13B |                                       |                          |
| Target: 14A |                                       |                          |
| 11          | <b>LYKKEBAEK, Martin</b><br>DENMARK   | <b>151</b><br>599 Quali. |
| 6           | <b>BEKE, Ludovice</b><br>BELGIUM      | <b>165</b><br>669 Quali. |
| Target: 14B |                                       |                          |
| Target: 15A |                                       |                          |
| 7           | <b>DANIELSSON, Staffan</b><br>SWEDEN  | **<br>669 Quali.         |
| 10          | <b>MASSARD, Edy</b><br>LUXEMBOURG     | 633 Quali.               |
| Target: 15B |                                       |                          |
| Target: 16A |                                       |                          |
| 15          |                                       | Quali.                   |
| 2           | <b>ANDERSEN, Andreas</b><br>DENMARK   | **<br>673 Quali.         |
| Target: 16B |                                       |                          |

|                                       |            |
|---------------------------------------|------------|
| Target: 9                             |            |
| <b>DAMSBO, Martin</b><br>DENMARK      | <b>111</b> |
| <b>VAMDEPOOLE, Mathieu</b><br>BELGIUM | <b>104</b> |

|                                   |            |
|-----------------------------------|------------|
| Target: 10                        |            |
| Target: 11                        |            |
| <b>LUNOGREN, Johan</b><br>SWEDEN  | <b>97</b>  |
| <b>RAVNJAK, Urban</b><br>SLOVENIA | <b>108</b> |

|                                   |            |
|-----------------------------------|------------|
| Target: 12                        |            |
| Target: 13                        |            |
| <b>NOERGAARD, Mads</b><br>DENMARK | <b>110</b> |
| <b>BEKE, Ludovice</b><br>BELGIUM  | <b>108</b> |

|                                      |            |
|--------------------------------------|------------|
| Target: 14                           |            |
| Target: 15                           |            |
| <b>DANIELSSON, Staffan</b><br>SWEDEN | <b>109</b> |
| <b>ANDERSEN, Andreas</b><br>DENMARK  | <b>111</b> |

|                                   |            |
|-----------------------------------|------------|
| Target: 13                        |            |
| <b>DAMSBO, Martin</b><br>DENMARK  | <b>110</b> |
| <b>RAVNJAK, Urban</b><br>SLOVENIA | <b>108</b> |

|                                     |            |
|-------------------------------------|------------|
| Target: 14                          |            |
| Target: 15                          |            |
| <b>NOERGAARD, Mads</b><br>DENMARK   | <b>115</b> |
| <b>ANDERSEN, Andreas</b><br>DENMARK | <b>109</b> |

**Final**  
1st and 2nd place

**Final**  
3rd and 4th place

**1/2 Final**

|                                     |            |
|-------------------------------------|------------|
| Target: 13                          |            |
| <b>NOERGAARD, Mads</b><br>DENMARK   | <b>113</b> |
| <b>DAMSBO, Martin</b><br>DENMARK    | <b>112</b> |
| Target: 14                          |            |
| Target: 13                          |            |
| <b>ANDERSEN, Andreas</b><br>DENMARK | <b>111</b> |
| <b>RAVNJAK, Urban</b><br>SLOVENIA   | <b>105</b> |
| Target: 14                          |            |

1st Place  
2nd Place  
3rd Place  
4th Place

**1/8 Finale**

**1/4 Final**

**Compound Junior Men**

\* = Won in shootout

European Junior Cup 2003 Finals  
20. - 25. May, Templin /Germany



|             |                                |
|-------------|--------------------------------|
| Target: 25A |                                |
| 1           | <b>BUDEN, Ivana</b> **         |
|             | CROATIA 683 Quali.             |
| 16          |                                |
| Target: 25B |                                |
| Target: 26A |                                |
| 9           | <b>JOHANSSON, Caroline</b> 138 |
|             | SWEDEN 605 Quali.              |
| 8           | <b>ANDERSEN, Patricia</b> 148  |
|             | DENMARK 608 Quali.             |
| Target: 26B |                                |
| Target: 27A |                                |
| 5           | <b>DANIELSSON, Isabella</b> ** |
|             | SWEDEN 644 Quali.              |
| 12          |                                |
| Target: 27B |                                |
| Target: 28A |                                |
| 13          |                                |
| 4           | <b>BOBERG, Sara</b> **         |
|             | SWEDEN 651 Quali.              |
| Target: 28B |                                |
| Target: 29A |                                |
| 3           | <b>MARSLEV, Rikke</b> **       |
|             | DENMARK 659 Quali.             |
| 14          |                                |
| Target: 29B |                                |
| Target: 30A |                                |
| 11          |                                |
| 6           | <b>ZECHA, Eva</b> **           |
|             | AUSTRIA 641 Quali.             |
| Target: 30B |                                |
| Target: 31A |                                |
| 7           | <b>HUNERSEN, Laila</b> **      |
|             | DENMARK 629 Quali.             |
| 10          |                                |
| Target: 31B |                                |
| Target: 32A |                                |
| 15          |                                |
| 2           | <b>SOEMOD, Camilla</b> **      |
|             | DENMARK 667 Quali.             |
| Target: 32B |                                |

|                           |     |
|---------------------------|-----|
| Target: 25                |     |
| <b>BUDEN, Ivana</b>       | 113 |
| CROATIA                   |     |
| <b>ANDERSEN, Patricia</b> | 103 |
| DENMARK                   |     |

|                     |     |
|---------------------|-----|
| Target: 26          |     |
| <b>BUDEN, Ivana</b> | 116 |
| CROATIA             |     |
| <b>BOBERG, Sara</b> | 106 |
| SWEDEN              |     |

|                             |     |
|-----------------------------|-----|
| Target: 27                  |     |
| <b>DANIELSSON, Isabella</b> | 99  |
| SWEDEN                      |     |
| <b>BOBERG, Sara</b>         | 111 |
| SWEDEN                      |     |

|                       |     |
|-----------------------|-----|
| Target: 28            |     |
| <b>MARSLEV, Rikke</b> | 106 |
| DENMARK               |     |
| <b>ZECHA, Eva</b>     | 104 |
| AUSTRIA               |     |

|                        |     |
|------------------------|-----|
| Target: 29             |     |
| <b>MARSLEV, Rikke</b>  | 114 |
| DENMARK                |     |
| <b>SOEMOD, Camilla</b> | 111 |
| DENMARK                |     |

|                        |     |
|------------------------|-----|
| Target: 30             |     |
| <b>MARSLEV, Rikke</b>  | 107 |
| DENMARK                |     |
| <b>HUNERSEN, Laila</b> | 98  |
| DENMARK                |     |

|                        |     |
|------------------------|-----|
| Target: 31             |     |
| <b>HUNERSEN, Laila</b> | 98  |
| DENMARK                |     |
| <b>SOEMOD, Camilla</b> | 107 |
| DENMARK                |     |

|                        |     |
|------------------------|-----|
| Target: 32             |     |
| <b>SOEMOD, Camilla</b> | 107 |
| DENMARK                |     |

|                     |     |
|---------------------|-----|
| Target: 29          |     |
| <b>BUDEN, Ivana</b> | 116 |
| CROATIA             |     |
| <b>BOBERG, Sara</b> | 106 |
| SWEDEN              |     |

|                       |     |
|-----------------------|-----|
| Target: 30            |     |
| <b>BUDEN, Ivana</b>   | 114 |
| CROATIA               |     |
| <b>MARSLEV, Rikke</b> | 107 |
| DENMARK               |     |

|                        |     |
|------------------------|-----|
| Target: 31             |     |
| <b>MARSLEV, Rikke</b>  | 114 |
| DENMARK                |     |
| <b>SOEMOD, Camilla</b> | 111 |
| DENMARK                |     |

|                        |     |
|------------------------|-----|
| Target: 32             |     |
| <b>SOEMOD, Camilla</b> | 107 |
| DENMARK                |     |

**Final**  
1st and 2nd place

**Final**  
3rd and 4th place

**1/2 Final**

**1/4 Final**

**1/8 Finale**

|                        |     |
|------------------------|-----|
| Target: 25             |     |
| <b>BUDEN, Ivana</b>    | 114 |
| CROATIA                |     |
| Target: 26             |     |
| Target: 25             |     |
| <b>BOBERG, Sara</b>    | 104 |
| SWEDEN                 |     |
| Target: 26             |     |
| Target: 25             |     |
| <b>SOEMOD, Camilla</b> | 102 |
| DENMARK                |     |

1st Place

2nd Place

3rd Place

4th Place

\* = Won in shootout

Compound Junior Women

# European Junior Cup 2003 Final Results

20. - 25. 2003 Templin /Germany

FITA Olympic Round

## Recurve Junior Men

| Pl. | Name                    | Nation         | Quali. | 1/32 | 1/16 | 1/8  | 1/4 | 1/2 | Final |
|-----|-------------------------|----------------|--------|------|------|------|-----|-----|-------|
| 1   | HELLYNCK, Julien        | FRANCE         | 639    | **   | 162  | 153* | 108 | 108 | 107   |
| 2   | SCAMMACCA, Ignazio      | ITALY          | 644    | **   | 143  | 154  | 101 | 102 | 105   |
| 3   | KRYVOCHENKO, Oleksiy    | UKRAINE        | 621    | **   | 160  | 162  | 102 | 99  | 99    |
| 4   | LUCKE, Tim              | GERMANY        | 637    | **   | 164  | 146  | 106 | 101 | 97    |
| 5   | KOLAY, Tayfun           | TURKEY         | 626    | **   | 152  | 150  | 106 |     |       |
| 6   | DUBAS, Igor             | UKRAINE        | 619    | **   | 160  | 153  | 99  |     |       |
| 7   | SZOKAL-EGIRD, Krzysztof | POLAND         | 622    | **   | 163  | 154  | 95  |     |       |
| 8   | POULSEN, Jacob Rujd     | DENMARK        | 605    | **   | 158  | 152  | 89  |     |       |
| 9   | AGDERE, Bahadir         | TURKEY         | 627    | **   | 153  | 153  |     |     |       |
|     | ZABOLIYAN, Oleksandr    | UKRAINE        | 611    | **   | 157  | 153  |     |     |       |
| 11  | WIESSE, Lutz            | GERMANY        | 582    | 146  | 160  | 151  |     |     |       |
| 12  | OLOFSSON, Martin        | SWEDEN         | 614    | **   | 157  | 145  |     |     |       |
| 13  | IGGENA, Jan             | GERMANY        | 624    | **   | 166  | 144  |     |     |       |
| 14  | ANDERLE, Alessandro     | ITALY          | 636    | **   | 153  | 143  |     |     |       |
|     | JAKOBSEN, Franz L.      | DENMARK        | 600    | **   | 157  | 143  |     |     |       |
| 16  | TONELLI, Amedeo         | ITALY          | 609    | **   | 159  | 138  |     |     |       |
| 17  | MAZGON, Rok             | SLOVENIA       | 638    | **   | 156  |      |     |     |       |
| 18  | MIKESKA, Jakub          | CZECH REPUBLIC | 595    | 149  | 152  |      |     |     |       |
| 19  | VASAUNE, David          | LUXEMBOURG     | 599    | 142  | 151  |      |     |     |       |
|     | AKESSON, Philip         | SWEDEN         | 592    | 144  | 151  |      |     |     |       |
|     | HLAVA, Alegs            | CZECH REPUBLIC | 612    | **   | 151  |      |     |     |       |
| 22  | EINROOS, Erki           | ESTONIA        | 517    | 138  | 150  |      |     |     |       |
|     | DE WACHTER, Kristof     | BELGIUM        | 603    | **   | 150  |      |     |     |       |
|     | GINZEL, Jan-Christoper  | GERMANY        | 597    | 148  | 150  |      |     |     |       |
|     | MIENKOWSKI, Jerzy       | POLAND         | 609    | **   | 150  |      |     |     |       |
| 26  | VOIRIN, Guillaume       | FRANCE         | 583    | 146  | 147  |      |     |     |       |
| 27  | VARECHON, Dimitri       | FRANCE         | 621    | **   | 146  |      |     |     |       |
| 28  | PAYA, Brice             | FRANCE         | 585    | 132  | 140  |      |     |     |       |
| 29  | CIS, Tomasz             | POLAND         | 601    | **   | 139  |      |     |     |       |
| 30  | ÖZCELIK, Memmet Ali     | TURKEY         | 605    | **   | 138  |      |     |     |       |
| 31  | PERKOV, Oleksandr       | UKRAINE        | 609    | **   | 135  |      |     |     |       |
| 32  | PEDERSEN, Kasper S.     | DENMARK        | 592    | 147  | 134  |      |     |     |       |
| 33  | TROJAN, Radek           | CZECH REPUBLIC | 556    | 142  |      |      |     |     |       |
|     | KOWALSKI, Bartlomiej    | POLAND         | 587    | 142  |      |      |     |     |       |
| 35  | KUKK, Eimar             | ESTONIA        | 561    | 138  |      |      |     |     |       |
|     | THORIN, Cristopher      | SWEDEN         | 523    | 138  |      |      |     |     |       |
| 37  | POVZ, Matej             | SLOVENIA       | 598    | 137  |      |      |     |     |       |
|     | SORLI, Damijan          | SLOVENIA       | 574    | 137  |      |      |     |     |       |
| 39  | CROCE, Valerio          | ITALY          | 589    | 135  |      |      |     |     |       |
| 40  | KOPPEL, Victor          | ESTONIA        | 487    | 118  |      |      |     |     |       |
| 41  | SELTER, Tarmo           | ESTONIA        | 584    | 115  |      |      |     |     |       |

# European Junior Cup 2003 Final Results

FITA Olympic Round

20. - 25. May, 2003 Templin /Germany

## Recurve Junior Women

| Rg. | Name                  | Nation         | Quali. | 1/16 | 1/8 | 1/4 | 1/2 | Final |
|-----|-----------------------|----------------|--------|------|-----|-----|-----|-------|
| 1   | DMYTRIUK, Kateryna    | UKRAINE        | 608    | 157  | 148 | 102 | 106 | 103   |
| 2   | SZYDLOWSKA, Agnieszka | POLAND         | 594    | 161  | 151 | 102 | 100 | 94    |
| 3   | GAUTHIER, Gaelle      | FRANCE         | 612    | 141  | 155 | 102 | 95  | 100   |
| 4   | KNUTSSON, Jennie      | SWEDEN         | 606    | 148  | 150 | 100 | 97  | 91    |
| 5   | TOMASI, Jessica       | ITALY          | 576    | 140  | 144 | 98  |     |       |
| 6   | LIONETTI, Pia Carmen  | ITALY          | 611    | 151  | 146 | 96  |     |       |
| 7   | HILLER, Halina        | GERMANY        | 620    | 143  | 146 | 95  |     |       |
| 8   | FRANGILLI, Carla      | ITALY          | 614    | 146  | 145 | 90  |     |       |
| 9   | FAYE, Sandra          | FRANCE         | 580    | 146  | 148 |     |     |       |
| 10  | PAVEL, Anne           | GERMANY        | 603    | 153  | 145 |     |     |       |
|     | BESKEN, Ilke          | TURKEY         | 585    | 149  | 145 |     |     |       |
|     | NORKOWSKA, Karolina   | POLAND         | 559    | 138* | 145 |     |     |       |
| 13  | MARTINERO, Sabrina    | BELGIUM        | 577    | 139  | 144 |     |     |       |
| 14  | WINTER, Karina        | GERMANY        | 623    | **   | 135 |     |     |       |
| 15  | RIEGER, Deborah       | GERMANY        | 554    | 144  | 135 |     |     |       |
| 16  | FRIGERI, Maura        | ITALY          | 568    | 144  | 134 |     |     |       |
| 17  | CESUR, Gülizar        | TURKEY         | 539    | 148  |     |     |     |       |
| 18  | TRZCIONKA, Alicja     | POLAND         | 593    | 144  |     |     |     |       |
| 19  | MELICHAROVA, Kristina | SLOVAKIA       | 560    | 142  |     |     |     |       |
|     | KRANTZ, Hanna         | SWEDEN         | 526    | 142  |     |     |     |       |
| 21  | BRANLANT, Laure       | FRANCE         | 544    | 141  |     |     |     |       |
| 22  | KUSHNIRUK, Olena      | UKRAINE        | 587    | 138  |     |     |     |       |
| 23  | RASKOVA, Hana         | CZECH REPUBLIC | 560    | 136  |     |     |     |       |
| 24  | NIEMIEC, Izabela      | POLAND         | 567    | 133  |     |     |     |       |
| 25  | CAKIR, Merve          | TURKEY         | 577    | 132  |     |     |     |       |
| 26  | MAZINA, Nataliya      | UKRAINE        | 552    | 130  |     |     |     |       |
|     | ALNEFELD, Anna        | SWEDEN         | 550    | 130  |     |     |     |       |
| 28  | CHAMBON, Anne         | FRANCE         | 535    | 127  |     |     |     |       |
| 29  | DOBLEKAR, Marjana     | SLOVENIA       | 572    | 121  |     |     |     |       |
| 30  | GODEC, Maja           | SLOVENIA       | 515    | 117  |     |     |     |       |
| 31  | NAGODE, Irena         | SLOVENIA       | 540    | 110  |     |     |     |       |



# European Junior Cup 2003 /Final Results

20. - 25. May, Templin /GER

FITA Olympic Round

## Compound Junior Men

| Pl. | Name                | Nation     | Quali. | 1/8 | 1/4 | 1/2 | Final |
|-----|---------------------|------------|--------|-----|-----|-----|-------|
| 1   | NOERGAARD, Mads     | DENMARK    | 671    | **  | 110 | 115 | 113   |
| 2   | DAMSBO, Martin      | DENMARK    | 680    | **  | 111 | 110 | 112   |
| 3   | ANDERSEN, Andreas   | DENMARK    | 673    | **  | 111 | 109 | 111   |
| 4   | RAVNJAK, Urban      | SLOVENIA   | 671    | **  | 108 | 108 | 105   |
| 5   | DANIELSSON, Staffan | SWEDEN     | 669    | **  | 109 |     |       |
| 6   | BEKE, Ludovice      | BELGIUM    | 669    | 165 | 108 |     |       |
| 7   | VAMDEPOOLE, Mathieu | BELGIUM    | 657    | 161 | 104 |     |       |
| 8   | LUNOGREN, Johan     | SWEDEN     | 670    | **  | 97  |     |       |
| 10  | BOSTROM, Erik       | SWEDEN     | 655    | 160 |     |     |       |
| 11  | LYKKEBAEK, Martin   | DENMARK    | 599    | 151 |     |     |       |
| 12  | MASSARD, Edy        | LUXEMBOURG | 633    |     |     |     |       |

## Compound Junior Women

| Pl. | Name                 | Nation  | Quali. | 1/8 | 1/4 | 1/2 | Final |
|-----|----------------------|---------|--------|-----|-----|-----|-------|
| 1   | BUDEN, Ivana         | CROATIA | 683    | **  | 113 | 116 | 114   |
| 2   | MARSLEV, Rikke       | DENMARK | 659    | **  | 106 | 114 | 107   |
| 3   | BOBERG, Sara         | SWEDEN  | 651    | **  | 111 | 106 | 104   |
| 4   | SOEMOD, Camilla      | DENMARK | 667    | **  | 107 | 111 | 102   |
| 5   | ZECHA, Eva           | AUSTRIA | 641    | **  | 104 |     |       |
| 6   | ANDERSEN, Patricia   | DENMARK | 608    | 148 | 103 |     |       |
| 7   | DANIELSSON, Isabella | SWEDEN  | 644    | **  | 99  |     |       |
| 8   | HUNERSEN, Laila      | DENMARK | 629    | **  | 98  |     |       |
| 9   | JOHANSSON, Caroline  | SWEDEN  | 605    | 138 |     |     |       |

# European Junior Cup 2003

## 20. - 25. May, 2003 Templin /GER

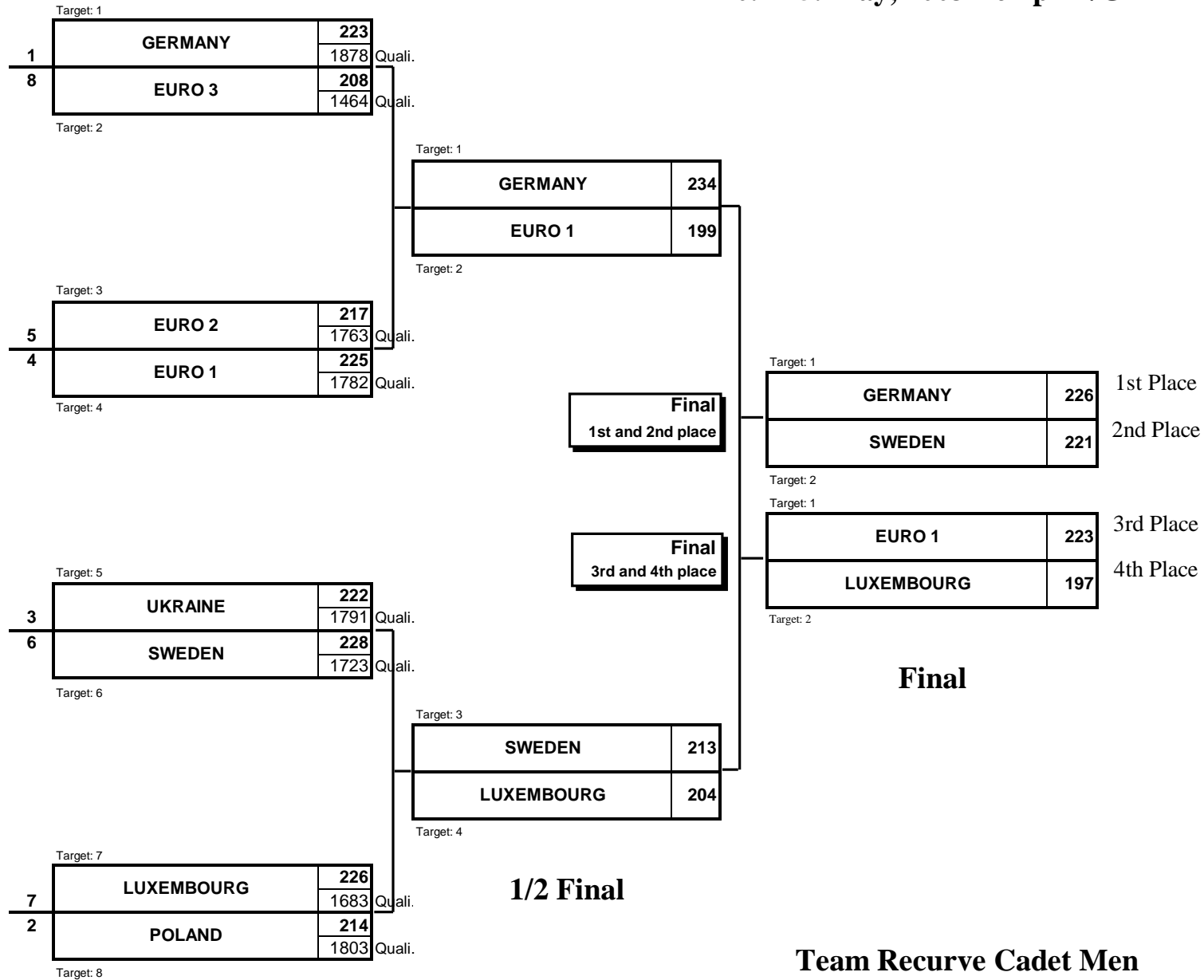

\* = Won in shootout

# European Junior Cup 2003

## 20. - 25. May, 2003 Templin /GER

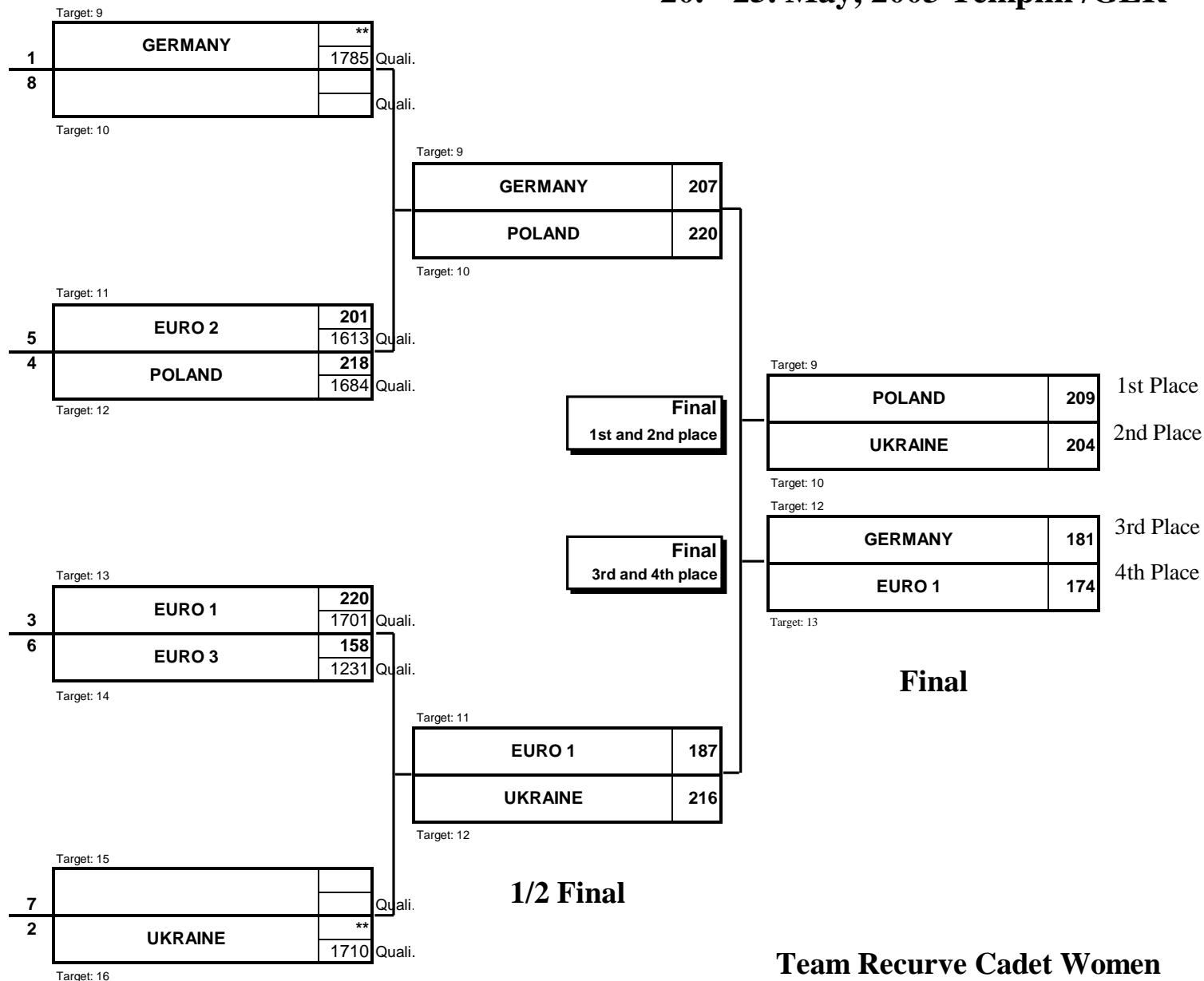

**1/4 Final**

**1/2 Final**

\* = Won in shootout

# European Junior Cup 2003

## 20. - 25. May, Templin /GER

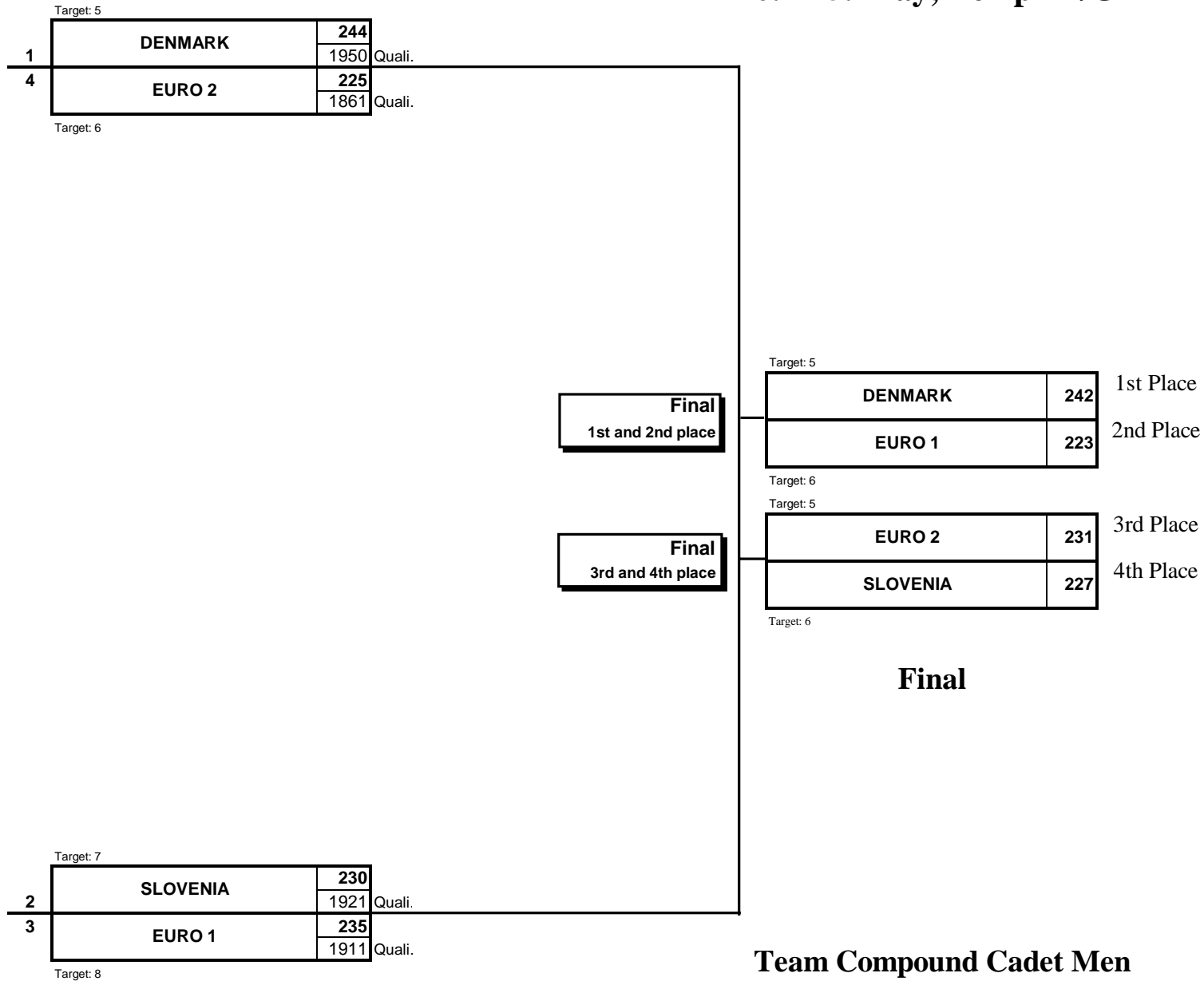

1/2 Final

\* = Won in shootout

# European Junior Cup 2003

20. - 25. May, 2003 Templin /GER

## Team Recurve Cadet Men

| Pl. | Name       | Quali. | 1/4 | 1/2 | Final |
|-----|------------|--------|-----|-----|-------|
| 1   | GERMANY    | 1878   | 223 | 234 | 226   |
| 2   | SWEDEN     | 1723   | 228 | 213 | 221   |
| 3   | EURO 1     | 1782   | 225 | 199 | 223   |
| 4   | LUXEMBOURG | 1683   | 226 | 204 | 197   |
| 5   | UKRAINE    | 1791   | 222 |     |       |
| 6   | EURO 2     | 1763   | 217 |     |       |
| 7   | POLAND     | 1803   | 214 |     |       |
| 8   | EURO 3     | 1464   | 208 |     |       |

## Team Recurve Cadet Women

| Pl. | Name    | Quali. | 1/4 | 1/2 | Final |
|-----|---------|--------|-----|-----|-------|
| 1   | POLAND  | 1684   | 218 | 220 | 209   |
| 2   | UKRAINE | 1710   | **  | 216 | 204   |
| 3   | GERMANY | 1785   | **  | 207 | 181   |
| 4   | EURO 1  | 1701   | 220 | 187 | 174   |
| 5   | EURO 2  | 1613   | 201 |     |       |
| 6   | EURO 3  | 1231   | 158 |     |       |

# European Junior Cup 2003

20. - 25. May, 2003 Templin /GER

## Team Compound Cadet Men

| Pl. | Name     | Quali. | 1/2 | Final |
|-----|----------|--------|-----|-------|
| 1   | DENMARK  | 1950   | 244 | 242   |
| 2   | EURO 1   | 1911   | 235 | 223   |
| 3   | EURO 2   | 1861   | 225 | 231   |
| 4   | SLOVENIA | 1921   | 230 | 227   |

# European Junior Cup 2003

## 20. - 25. May, 2003 Templin /GER

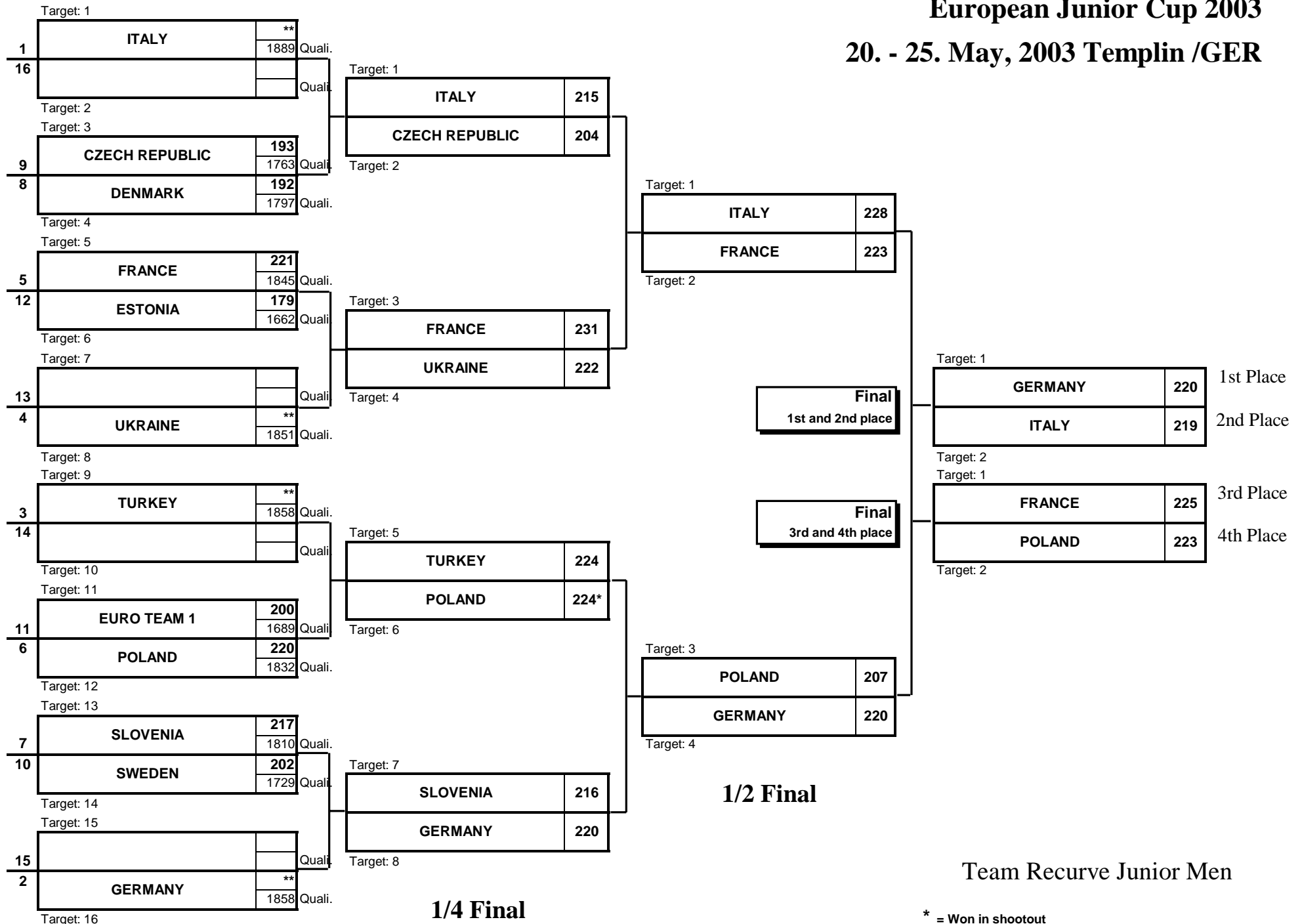

**1/8 Finale**

**1/4 Final**

**1/2 Final**

**Final**  
1st and 2nd place

**Final**  
3rd and 4th place

Team Recurve Junior Men

# European Junior Cup 2003

## 20. - 25. May, 2003 Templin /GER

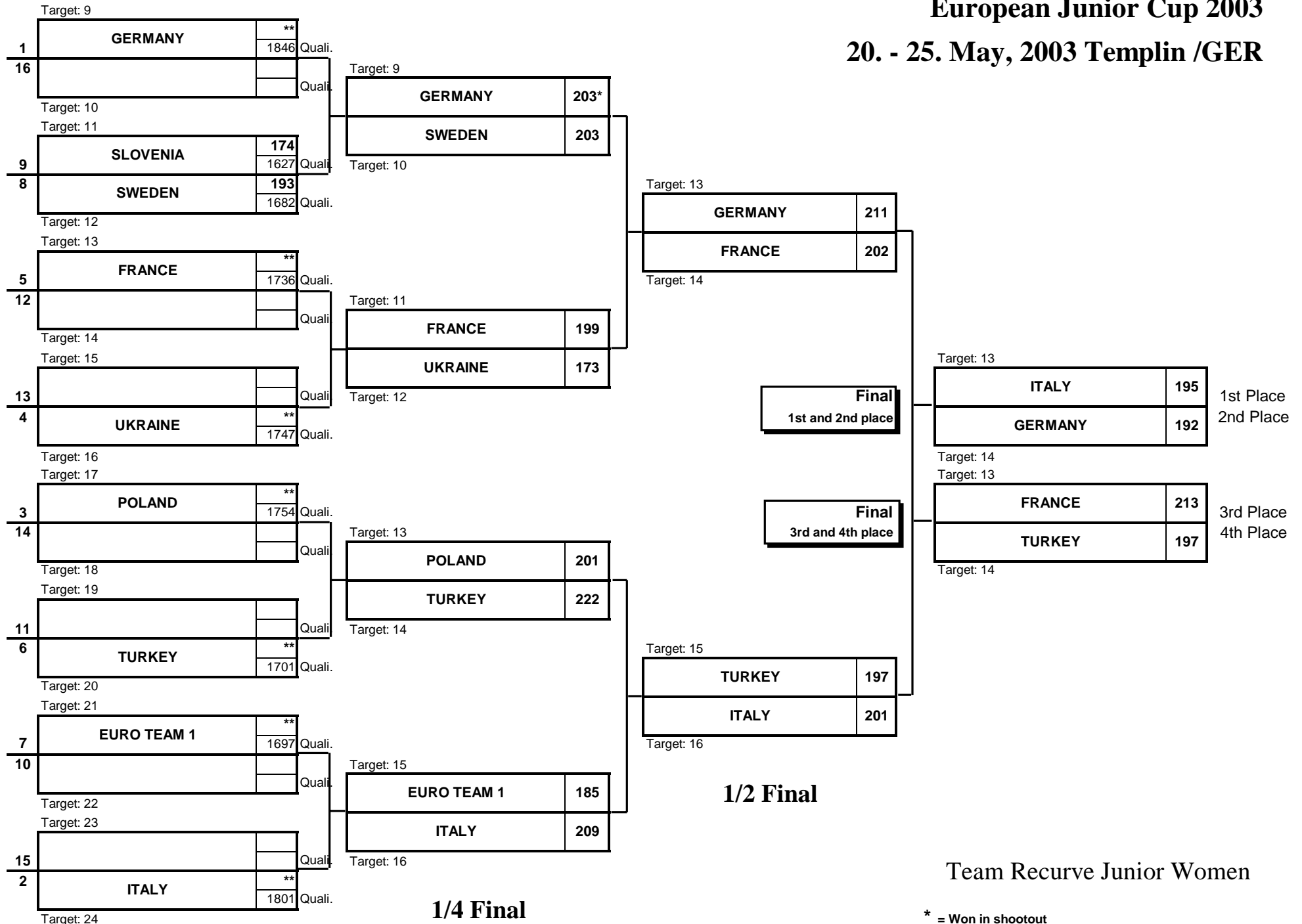

\* = Won in shootout

Team Recurve Junior Women



# European Junior Cup 2003

## 20. - 25. May, Templin /GER

Target: 5

|   |         |      |        |
|---|---------|------|--------|
| 1 | DENMARK | **   | Quali. |
|   |         | 2024 |        |
| 4 |         |      | Quali. |

Target: 6

**Final**  
1st and 2nd place

Target: 5

|         |     |           |
|---------|-----|-----------|
| DENMARK | 246 | 1st Place |
| EURO    | 241 | 2nd Place |

**Final**  
3rd and 4th place

Target: 6

Target: 5

|        |  |           |
|--------|--|-----------|
| SWEDEN |  | 3rd Place |
|        |  | 4th Place |

Target: 6

**Final**

Target: 7

|   |        |      |        |
|---|--------|------|--------|
| 2 | EURO   | 231  | Quali. |
|   |        | 1997 |        |
| 3 | SWEDEN | 205  | Quali. |
|   |        | 1994 |        |

Target: 8

**1/2 Final**

**Team Compound Junior Men**

\* = Won in shootout

# European Junior Cup 2003

## 20. - 25. May, Templin /GER

Target: 9

|   |         |      |        |
|---|---------|------|--------|
| 1 | DENMARK | **   | Quali. |
|   |         | 1955 |        |
| 4 |         |      | Quali. |

Target: 10

**Final**  
1st and 2nd place

Target: 9

|         |     |           |
|---------|-----|-----------|
| EURO    | 219 | 1st Place |
| DENMARK | 218 | 2nd Place |

**Final**  
3rd and 4th place

Target: 10

Target: 9

|        |  |           |
|--------|--|-----------|
| SWEDEN |  | 3rd Place |
|        |  | 4th Place |

**Final**

Target: 11

|   |        |      |        |
|---|--------|------|--------|
| 2 | EURO   | 244  | Quali. |
|   |        | 1925 |        |
| 3 | SWEDEN | 229  | Quali. |
|   |        | 1900 |        |

Target: 12

**1/2 Final**

**Team Compound Junior Women**

\* = Won in shootout

# European Junior Cup 2003

20. - 25. May, 2003 Templin /GER

## Team Recurve Junior Men

| Pl. | Name           | Quali. | 1/8 | 1/4  | 1/2 | Final |
|-----|----------------|--------|-----|------|-----|-------|
| 1   | GERMANY        | 1858   | **  | 220  | 220 | 220   |
| 2   | ITALY          | 1889   | **  | 215  | 228 | 219   |
| 3   | FRANCE         | 1845   | 221 | 231  | 223 | 225   |
| 4   | POLAND         | 1832   | 220 | 224* | 207 | 223   |
| 5   | TURKEY         | 1858   | **  | 224  |     |       |
| 6   | UKRAINE        | 1851   | **  | 222  |     |       |
| 7   | SLOVENIA       | 1810   | 217 | 216  |     |       |
| 8   | CZECH REPUBLIC | 1763   | 193 | 204  |     |       |
| 9   | SWEDEN         | 1729   | 202 |      |     |       |
| 10  | EURO TEAM 1    | 1689   | 200 |      |     |       |
| 11  | DENMARK        | 1797   | 192 |      |     |       |
| 12  | ESTONIA        | 1662   | 179 |      |     |       |

## Team Recurve Junior Women

| Pl. | Name        | Quali. | 1/8 | 1/4  | 1/2 | Final |
|-----|-------------|--------|-----|------|-----|-------|
| 1   | ITALY       | 1801   | **  | 209  | 201 | 195   |
| 2   | GERMANY     | 1846   | **  | 203* | 211 | 192   |
| 3   | FRANCE      | 1736   | **  | 199  | 202 | 213   |
| 4   | TURKEY      | 1701   | **  | 222  | 197 | 197   |
| 5   | SWEDEN      | 1682   | 193 | 203  |     |       |
| 6   | POLAND      | 1754   | **  | 201  |     |       |
| 7   | EURO TEAM 1 | 1697   | **  | 185  |     |       |
| 8   | UKRAINE     | 1747   | **  | 173  |     |       |
| 9   | SLOVENIA    | 1627   | 174 |      |     |       |

# European Junior Cup 2003 /Final Results

20. - 25. May, Templin /GER

## Team Compound Junior Men

| Pl. | Name    | Quali. | 1/2 | Final |
|-----|---------|--------|-----|-------|
| 1   | DENMARK | 2024   | **  | 246   |
| 2   | EURO    | 1997   | 231 | 241   |
| 3   | SWEDEN  | 1994   | 205 |       |

## Team Compound Junior Women

| Pl. | Name    | Quali. | 1/2 | Final |
|-----|---------|--------|-----|-------|
| 1   | EURO    | 1925   | 244 | 219   |
| 2   | DENMARK | 1955   | **  | 218   |
| 3   | SWEDEN  | 1900   | 229 |       |



# NEW RECORDS

| <b>INDIVIDUAL</b>     |                               |                  |                |                   |                   |
|-----------------------|-------------------------------|------------------|----------------|-------------------|-------------------|
| <b>Division</b>       | <b>Type of Record</b>         | <b>Name</b>      | <b>Country</b> | <b>New Record</b> | <b>Old Record</b> |
| Recurve Cadet Men     | 72 Arrows Qualification Round | FLOTO, Florian   | GER            | 652 E/-           | 649 E/-           |
| Recurve Cadet Woman   | 72 Arrows Qualification Round | POSSNER, Susanne | GER            | 628 E/W           | 626 E/W           |
| Compound Junior Woman | 72 Arrows Qualification Round | BUDEN, Ivana     | CRO            | 683 E/W           | 672 E/W           |

| <b>TEAM</b>         |                                 |  |                |                   |                   |
|---------------------|---------------------------------|--|----------------|-------------------|-------------------|
| <b>Division</b>     | <b>Type of Record</b>           | <b>Name</b>  | <b>Country</b> | <b>New Record</b> | <b>Old Record</b> |
| Compound Junior Men | 3x72 Arrows Qualification Round | DAMSBO, Martin<br>ANDERSEN, Andreas<br>NOERGAARD, Mads | DEN            | 2024 E/W          | 1999 E/W          |
|                     |                                 |  |                |                   |                   |

E=European Record  
W=World Record